

THIS DOCUMENT IS SUBJECT TO CHANGE WITHOUT NOTICE. IT IS CONFIDENTIAL AND A PROPERTY OF Amphenol LTW. DISCLOSURE TO THIRD PARTY HAS TO BE AUTHORIZED BY Amphenol LTW.

REV.	ECN NO.	DATE	SIGN	DESCRIPTION
A		2020/04/22	Peng	Initial Released

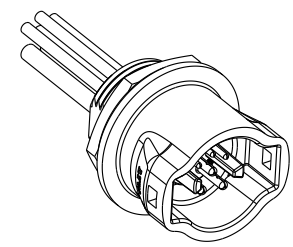
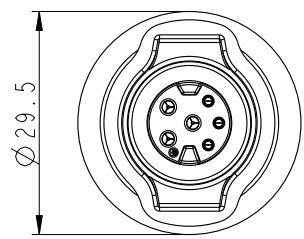
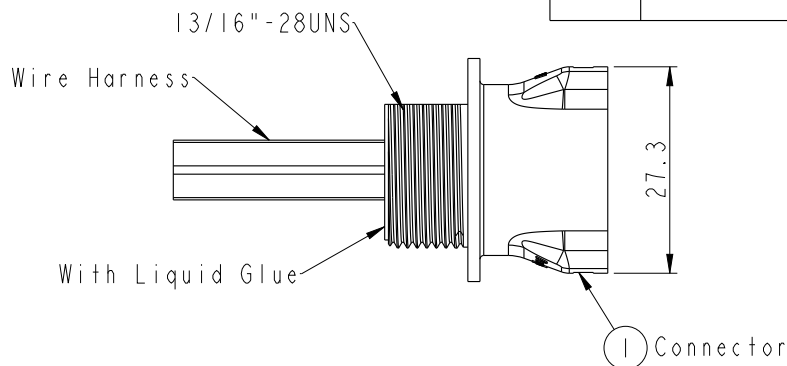

CBD-06RFMS-RC8CXX

06:6Pin

- 10:100mm
- 15:150mm
- 20:200mm
- :
- A0:1000mm
- Cable Pitch Unit=50mm
- Wire Length (L):100~1000 mm

Note:

- * \varnothing Important Dimension To Check.
- * Waterproof Rate: IP68, Unmated.
IP68:1M depth of water in 24 hours
- * Connector: Thermoplastic, Black.
- * Male Pin: Copper Alloy, Gold Plated.
- * Gasket: Rubber, Black.
- * Nut: Thermoplastic,Black.
- * Wire Harnss: UL1015
- * Panel Thickness Max: 5.0mm
- * Recommended Nut Torque:8~10 kgf.cm
- * Wire harness Tolerance: 100mm ±10mm
101~300mm ±15mm
301~1000mm ±20mm
- * Prohibiting the use of place in oils
- * The nut and gasket are packed separately

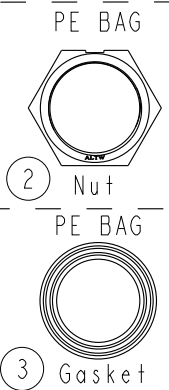
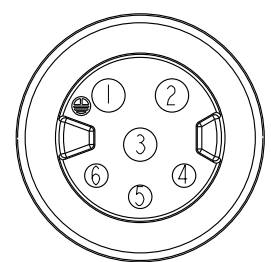
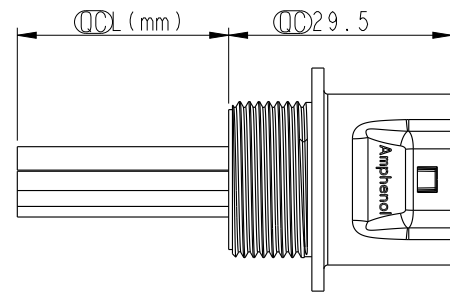
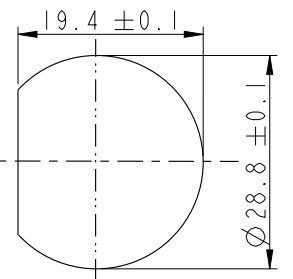

6	Black (20AWG)	黑
5	White (20AWG)	白
4	Green (20AWG)	綠
3	Bule (16AWG)	藍
2	Red (16AWG)	紅
1	Black (16AWG)	黑
Conn.	Wire Color	
	Pin Out	

UNIT:mm

TOLERANCE ±0.5

TITLE MIDDLE PANEL RBL F CONN M PIN

SCALE 1:1	SIZE A4	SHEET 1 OF 1
REV. A	WC-REV. .0	\varnothing : Inspection item

Amphenol LTW
安費諾亮泰企業股份有限公司

ITEM NO	DRAWN BY Peng	DATE 2020-04-22
DWG NO CBD-XXRFMS-RC8CXX	CHECKED BY Mafei	DATE 2020-04-22
CUSTOMER ALTW	APPROVED BY Jerry	DATE 2020-04-22