

THIS DOCUMENT IS SUBJECT TO CHANGE WITHOUT NOTICE. IT IS CONFIDENTIAL AND A PROPERTY OF AMPHENOL LTW. DISCLOSURE TO THIRD PARTY HAS TO BE AUTHORIZED BY AMPHENOL LTW.

REV.	ECN NO.	DATE	SIGN	DESCRIPTION
B	C220467	2022/03/29	Vicky	△B X2
C	C221118	2022/07/26	Vicky	△C X1
D	C230128	2023/02/09	Ruru	△D X1

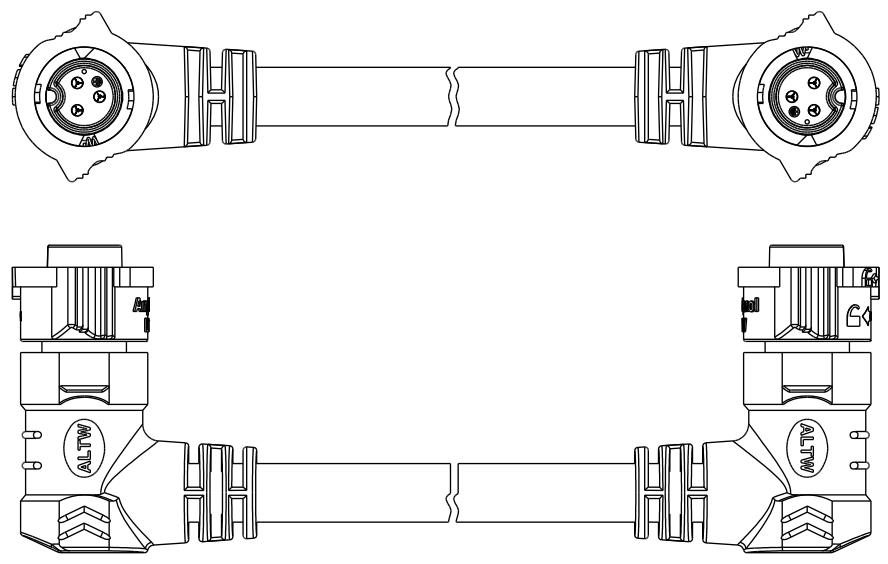
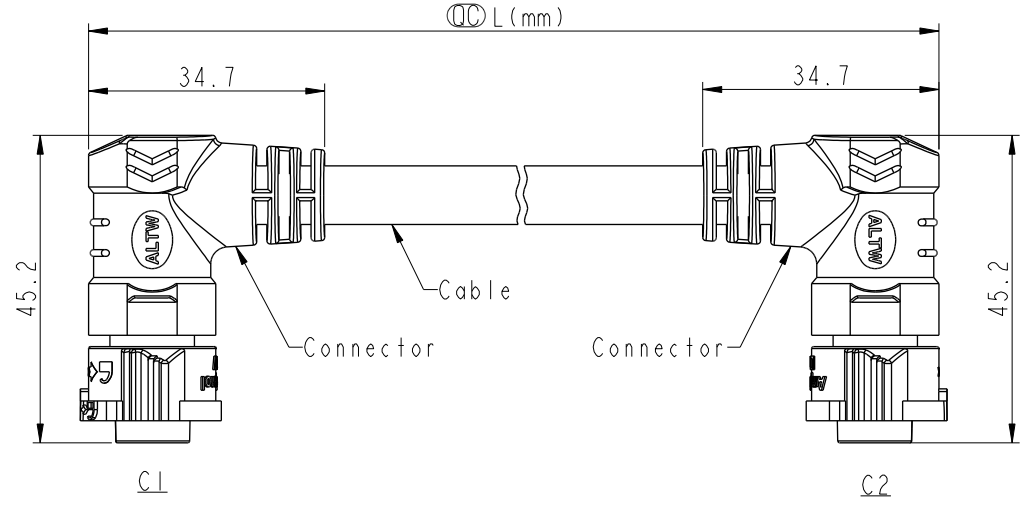

- △ Note:
- * RoHS Compliant
 - * Ⓞ Important dimension
 - △ * Waterproof rate: IP68, mated 1m/24h
 - * Connector
 - Housing: Thermoplastic, Black
 - Pin: Copper alloy, Gold plated
 - O-Ring: Rubber, Dark gray
 - Nut: Thermoplastic, Black
 - Outer Mold: Thermoplastic, Black
 - * Cable: SJTW, PVC Jacket, Black
 - * Cable length tolerance:

0.5M < L	≤	1M	: +60/-0 mm
1M < L	≤	3M	: +120/-0 mm
3M < L	≤	5M	: +160/-0 mm
5M < L	≤	10M	: ±100 mm
10M < L	≤	20M	: ±200 mm
20M < L	≤	30M	: ±300 mm
30M < L	≤	99M	: ±500 mm

UNIT: mm

TOLERANCE

±0.5mm

TITLE
ACC, XLOK, B-10A, DB-ENDED
FF

SCALE 1:2 SIZE A4 SHEET 1 OF 2

REV. D WC-REV. A.5 Ⓞ: Inspection item

Amphenol LTW
安費諾亮泰企業股份有限公司

ITEM NO.	DRAWN BY	DATE
	Vicky	2020-01-20
DWG NO.	CHECKED BY	DATE
AB-BBXXBR-BBBR-QEXXX	Rita	2020-01-20
CUSTOMER	APPROVED BY	DATE
ALTW	Max	2020-01-20



THIS DOCUMENT IS SUBJECT TO CHANGE WITHOUT NOTICE. IT IS CONFIDENTIAL AND A PROPERTY OF Amphenol LTW. DISCLOSURE TO THIRD PARTY HAS TO BE AUTHORIZED BY Amphenol LTW.

3P	PVC	8.6	16	AB-BB03BR-BBBR-QEXXX
2P		8.2		AB-BB02BR-BBBR-QEXXX
Contacts	Cable Jacket	Cable OD	AWG	Item No.

AB-BB XX BR-BBBR-QE XXX

 XX: No. Of Pin

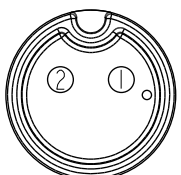
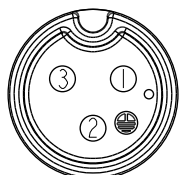
XXX: 0.5~99Meters
A05: 0.5 Meter
001: 01 Meter
002: 02 Meters
:
099: 99 Meters

Pin Out	2 White 1 Black	白 黑	3 Green 2 White 1 Black	綠 白 黑
	Pin #	Wire	Pin #	Wire
C1 & C2				
	2P		3P	

Pin Assignments Front View

UNIT:mm		TITLE	ACC, XLOK, B-10A, DB-ENDED FF	
TOLERANCE	±0.5mm	SCALE	1:2	SIZE A4
		REV.	D	WC-REV. A.5
				SHEET 2 OF 2
				QC: Inspection item

Amphenol LTW
安費諾亮泰企業股份有限公司

ITEM NO	DRAWN BY	DATE
	Vicky	2020-01-20
DWG NO	CHECKED BY	DATE
AB-BBXXBR-BBBR-QEXXX	Rita	2020-01-20
CUSTOMER	APPROVED BY	DATE
ALTW	Max	2020-01-20