

REV.	ECN NO.	DATE	SIGN	DESCRIPTION
A		2020/02/03	Vicky	Initial Released
B	C220642	2022/04/28	Ruru	$\triangle B$ X2
C	C230094	2023/02/02	Vicky	$\triangle C$ X2

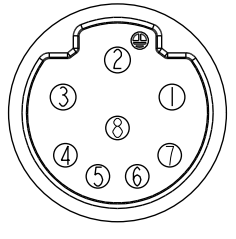

C2
Pin Assignments
Front View

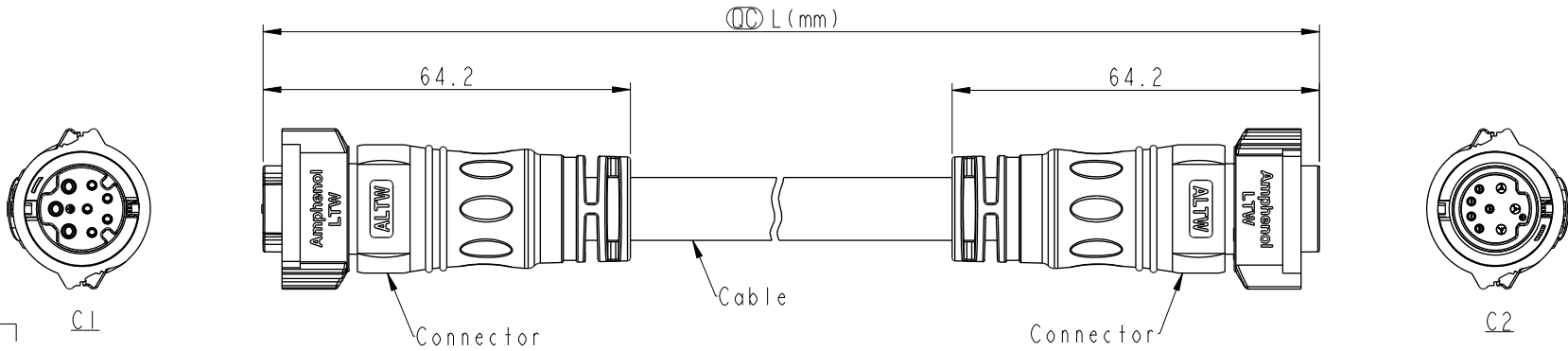
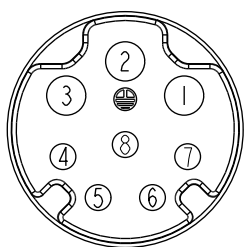

C1
Pin Assignments
Front View

8	Drain (26AWG)	地線	
7	Blue (26AWG)	藍	Twist 對線
6	Red (26AWG)	紅	
5	Green (26AWG)	綠	Twist 對線
4	White (26AWG)	白	
3	Black (16AWG)	黑	
2	Green (16AWG)	綠	
1	White (16AWG)	白	
C1 & C2	Wire Color		
Pin Out			

UNIT:mm		
TOLERANCE	$\pm 0.5\text{mm}$	

TITLE ACC, XLOK, C-10A+5A, DB-ENDED FF		
SCALE 33:100	SIZE A4	SHEET 1 OF 2
REV. C	WC-REV. A.5	\odot : Inspection item

Amphenol LTW
安費諾亮泰企業股份有限公司

ITEM NO.	DRAWN BY Vicky	DATE 2020-02-03
DWG NO. AB-CBDXXFL-CBDBL-QFXXX	CHECKED BY Rita	DATE 2020-02-03
CUSTOMER ALTW	APPROVED BY Max	DATE 2020-02-03

THIS DOCUMENT IS SUBJECT TO CHANGE WITHOUT NOTICE. IT IS CONFIDENTIAL AND A PROPERTY OF Amphenol LTW. DISCLOSURE TO THIRD PARTY HAS TO BE AUTHORIZED BY Amphenol LTW.

AB-CBD XX FL-CBDBL-QF XXX

 XX: No. Of Pin

XXX: 0.5~99Meters
 A05: 0.5 Meter
 001: 01 Meter
 002: 02 Meters
 :
 099: 99 Meters

Note: 

- * RoHS Compliant
- *  Important dimension
- * CI

 Waterproof rate: IP68, mated 1m/24h
 Housing: Thermoplastic, Black
 Pin: Copper Alloy, Gold Plated
 O-Ring: Rubber, Gray
 Nut: Thermoplastic, Black
 Outer mold: Thermoplastic, Black

- * C2

 Waterproof rate: IP68, mated 1m/24h
 Housing: Thermoplastic, Black
 Pin: Copper Alloy, Gold Plated
 O-Ring: Rubber, Gray
 Nut: Thermoplastic, Black
 Outer mold: Thermoplastic, Black

- * Cable: UL21996, 16#*3C+(26#*2P+D+AL/MY)+AL/MY,
 OD=11.0mm, PVC Jacket, Black
- * Cable length tolerance: 0.5M < L ≤ 1M: +60/-0 mm
 1M < L ≤ 3M: +120/-0 mm
 3M < L ≤ 5M: +160/-0 mm
 5M < L ≤ 10M: ±100 mm
 10M < L ≤ 20M: ±200 mm
 20M < L ≤ 30M: ±300 mm
 30M < L ≤ 99M: ±500 mm

UNIT:mm TOLERANCE	 	TITLE ACC, XLOK, C-10A+5A, DB-ENDED FF		<h2 style="text-align: center;">Amphenol LTW</h2> <p style="text-align: center;">安費諾亮泰企業股份有限公司</p>	ITEM NO	DRAWN BY Vicky	DATE 2020-02-03	
		SCALE 33:100	SIZE A4		SHEET 2 OF 2	DWG NO AB-CBDXXFL-CBDBL-QFXXX	CHECKED BY Rita	DATE 2020-02-03
		REV. C	WC-REV. A.5		 : Inspection item	CUSTOMER ALTW	APPROVED BY Max	DATE 2020-02-03