

THIS DOCUMENT IS SUBJECT TO CHANGE WITHOUT NOTICE. IT IS CONFIDENTIAL AND A PROPERTY OF Amphenol LTW. DISCLOSURE TO THIRD PARTY HAS TO BE AUTHORIZED BY Amphenol LTW.

REV.	ECN NO.	DATE	SIGN	DESCRIPTION
E	C220487	2022/04/01	Vicky	△E X4
F	C230087	2023/01/30	Vicky	△F X2
G	C240236	2024/03/07	Vicky	△G X2

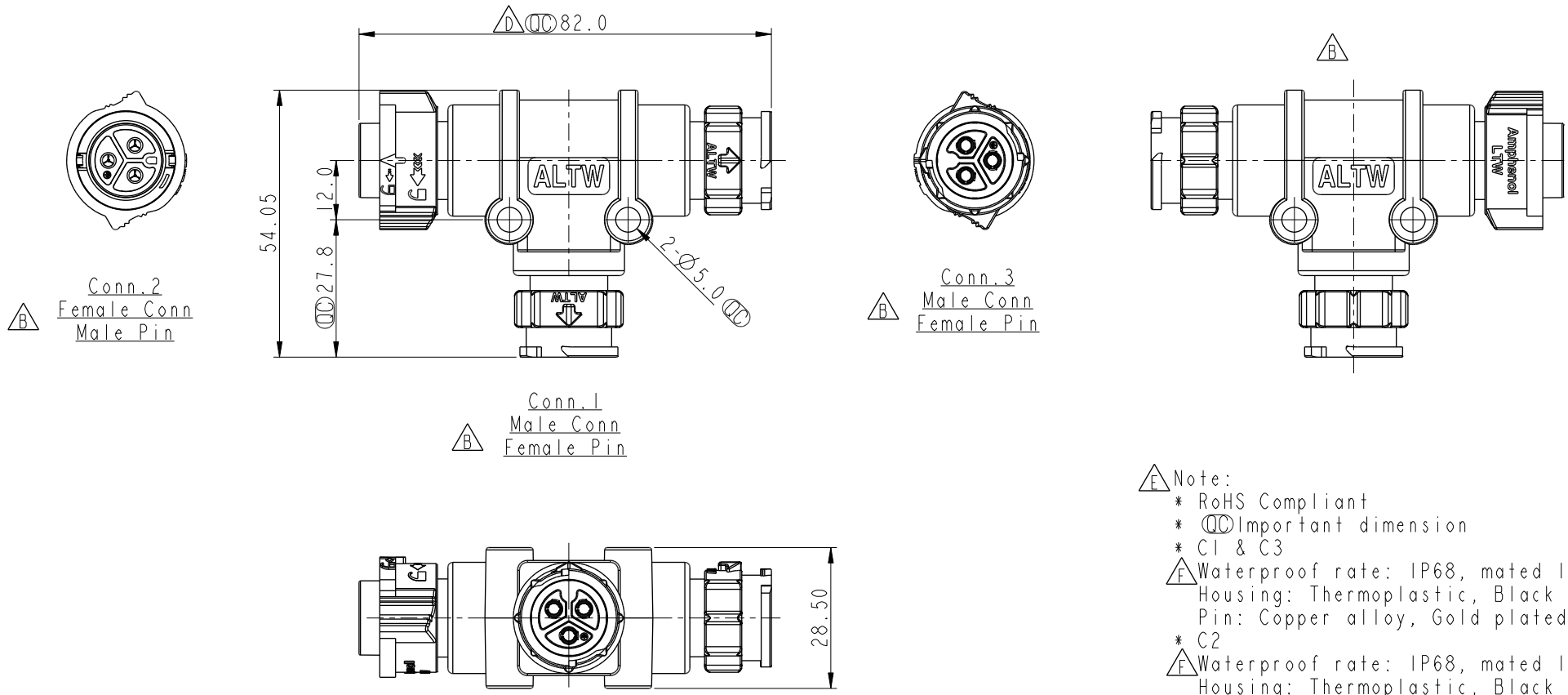

- △E Note:
- * RoHS Compliant
 - * ∅ Important dimension
 - * C1 & C3
 - △E Waterproof rate: IP68, mated 1m/24h
Housing: Thermoplastic, Black
Pin: Copper alloy, Gold plated
 - * C2
 - △E Waterproof rate: IP68, mated 1m/24h
Housing: Thermoplastic, Black
Pin: Copper alloy, Gold plated
O-Ring: Rubber, Gray
Nut: Thermoplastic, Black
 - * Wire: UL1007, 16AWG
 - * Wire: UL1015, 14AWG
 - * Outer Mold: Thermoplastic, Black

UNIT: mm		TITLE ACC, XLOK, C-20A, T ADA W/O CB MFM
TOLERANCE ±0.5mm	SCALE 1:1	SIZE A4
	REV. G	WC-REV. .0
		SHEET 1 OF 2
		∅: Inspection item

Amphenol LTW
安費諾亮泰企業股份有限公司

ITEM NO	DRAWN BY Ouyang	DATE 2019-08-02
DWG NO AB-CC-XXXXXX-HBH-TQ001	CHECKED BY Jerry	DATE 2019-08-02
CUSTOMER ALTW	APPROVED BY Fred	DATE 2019-08-02

THIS DOCUMENT IS SUBJECT TO CHANGE WITHOUT NOTICE. IT IS CONFIDENTIAL AND A PROPERTY OF Amphenol LTW. DISCLOSURE TO THIRD PARTY HAS TO BE AUTHORIZED BY Amphenol LTW.

AB-CC-XXXXXX-HBH-TQ001



XXXXXX: No. Of Pin

Connection Diagram

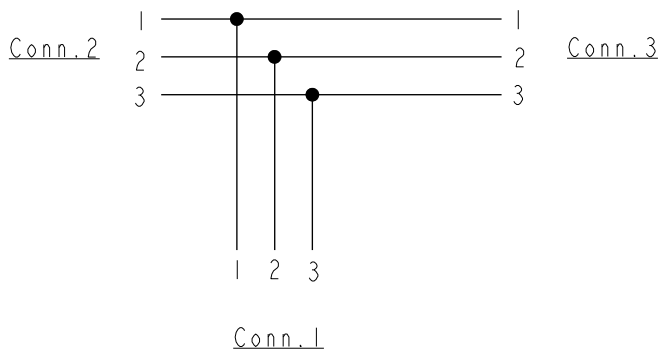

Pin Assignments Front View

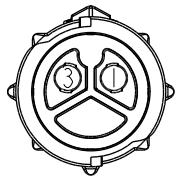
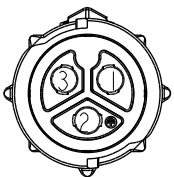
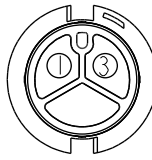
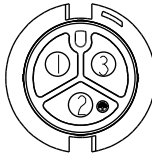
	Pin Assignments Front View	
	2 Pin	3 Pin
Male		
Female		
Pin Out	Pin# Color	Pin# Color
	Pin1 White 白 Pin3 Black 黑	Pin1 White 白 Pin2 Green 綠 Pin3 Black 黑

UNIT:mm

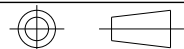

TOLERANCE

±0.5mm

TITLE ACC, XLOK, C-20A, T ADA W/O CB
MFM

SCALE 1:1

SIZE A4

SHEET 2 OF 2

REV. G

WC-REV. .0

Inspection item

Amphenol LTW

安費諾亮泰企業股份有限公司

ITEM NO

DWG NO

AB-CC-XXXXXX-HBH-TQ001

CUSTOMER

ALTW

DRAWN BY

Ouyang

CHECKED BY

Jerry

APPROVED BY

Fred

DATE

2019-08-02

DATE

2019-08-02

DATE

2019-08-02