

THIS DOCUMENT IS SUBJECT TO CHANGE WITHOUT NOTICE. IT IS CONFIDENTIAL AND A PROPERTY OF AMPHENOL LTW. DISCLOSURE TO THIRD PARTY HAS TO BE AUTHORIZED BY AMPHENOL LTW.

REV.	ECN NO.	DATE	SIGN	DESCRIPTION
A		2020/01/09	Ruru	Initial Released
B	C220462	2022/03/29	Ruru	△B X2
C	C230117	2023/02/07	Vicky	△C XI

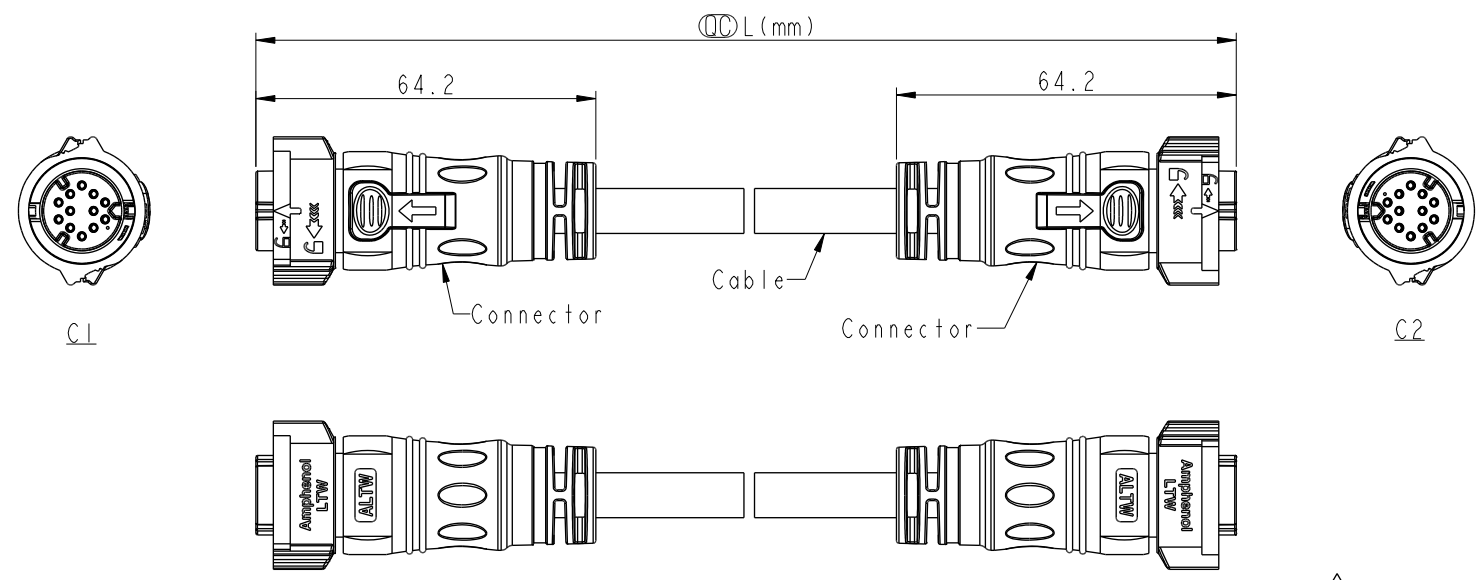

- Note: △B
- * RoHS Compliant
 - * Ⓞ Important dimension
 - △C * Waterproof rate: IP68, mated 1m/24h
 - * Connector
 - Housing: Thermoplastic, Black
 - Pin: Copper Alloy, Gold Plated
 - O-Ring: Rubber, Gray
 - Nut: Thermoplastic, Black
 - Outer mold: Thermoplastic, Black
 - * Cable: UL21388, PVC Jacket, Black
 - * Cable length tolerance: 0.5M < L ≤ 1M: +60/-0 mm
 - 1M < L ≤ 3M: +120/-0 mm
 - 3M < L ≤ 5M: +160/-0 mm
 - 5M < L ≤ 10M: ±100 mm
 - 10M < L ≤ 20M: ±200 mm
 - 20M < L ≤ 30M: ±300 mm
 - 30M < L ≤ 99M: ±500 mm

UNIT:mm		TITLE	ACC, XLOK, C-5A, DB-ENDED FF		
TOLERANCE	±0.5 mm	SCALE	1:2	SIZE	A4
		REV.	C	WC-REV.	
				Ⓞ	Inspection item

Amphenol LTW
安費諾亮泰企業股份有限公司

ITEM NO	DRAWN BY	DATE
	Ruru	2020-01-09
DWG NO	CHECKED BY	DATE
AB-CDXXFL-CDFL-QDXXX	Rita	2020-01-09
CUSTOMER	APPROVED BY	DATE
ALTW	Max	2020-01-09

THIS DOCUMENT IS SUBJECT TO CHANGE WITHOUT NOTICE. IT IS CONFIDENTIAL AND A PROPERTY OF Amphenol LTW. DISCLOSURE TO THIRD PARTY HAS TO BE AUTHORIZED BY Amphenol LTW.

12P	PVC	8.5	20	AB-CD12FL-CDFL-QDXXX
10P		8.5		AB-CD10FL-CDFL-QDXXX
9P		7.6		AB-CD09FL-CDFL-QDXXX
8P		7.2		AB-CD08FL-CDFL-QDXXX
7P		6.8		AB-CD07FL-CDFL-QDXXX
Contacts	Cable Jacket	Cable OD	AWG	Item No.

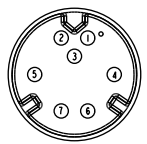
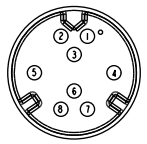
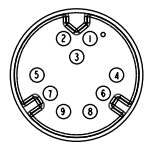
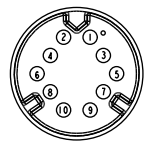
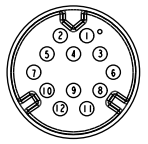

 AB- CD XX FL - CD FL - Q D XXX
 XX: No. Of Pin
 XXX: 0.5~99Meters
 A05: 0.5 Meter
 001: 01 Meter
 002: 02 Meters
 :
 099: 99 Meters

Pin Out	Wire	Pin #	Wire	Pin #	Wire	Pin #	Wire	Pin #	Wire	Pin #	Wire
7	Orange 橙	8	Green 綠	9	Brown 棕	10	White 白	12	Light Green 淡綠		
6	Blue 藍	7	Orange 橙	8	Green 綠	9	Gray 灰	11	Pink 粉紅		
8	Green 綠	6	Blue 藍	7	Orange 橙	8	Purple 紫	10	White 白		
4	Yellow 黃	5	Purple 紫	6	Blue 藍	7	Blue 藍	9	Gray 灰		
3	Black 黑	4	Yellow 黃	5	Purple 紫	6	Green 綠	8	Purple 紫		
2	Red 紅	3	Black 黑	4	Yellow 黃	5	Yellow 黃	7	Blue 藍		
1	Brown 棕	2	Red 紅	3	Black 黑	4	Orange 橙	6	Green 綠		
		1	Brown 棕	2	Red 紅	3	Red 紅	5	Yellow 黃		
				1	Gray 灰	2	Brown 棕	4	Orange 橙		
							1	Black 黑	3	Red 紅	
								2	Brown 棕		
								1	Black 黑		

CI & C2	Diagram	Diagram	Diagram	Diagram	Diagram
					
	7P	8P	9P	10P	12P

Pin Assignments Front View

UNIT:mm  
 TOLERANCE
 ± 0.5 mm

TITLE ACC, XLOK, C-5A, DB-ENDED
 FF
 SCALE 1:2 SIZE A4 SHEET 2 OF 2
 REV. C WC-REV. :Inspection item

Amphenol LTW
 安費諾亮泰企業股份有限公司

ITEM NO	DWG NO	CUSTOMER	DRAWN BY	CHECKED BY	APPROVED BY	DATE
	AB-CDXXFL-CDFL-QDXXX	ALTW	Ruru	Rita	Max	2020-01-09