

THIS DOCUMENT IS SUBJECT TO CHANGE WITHOUT NOTICE. IT IS CONFIDENTIAL AND A PROPERTY OF Amphenol LTW. DISCLOSURE TO THIRD PARTY HAS TO BE AUTHORIZED BY Amphenol LTW.

REV.	ECN NO.	DATE	SIGN	DESCRIPTION
A	Initial Release	2018/06/20	Mafei	Change Rev.01 To Rev.A
B	E191814	2019/10/22	Ruru	$\triangle B$ X3
C	C220370	2022/03/10	Xiaofeng	$\triangle C$ XI

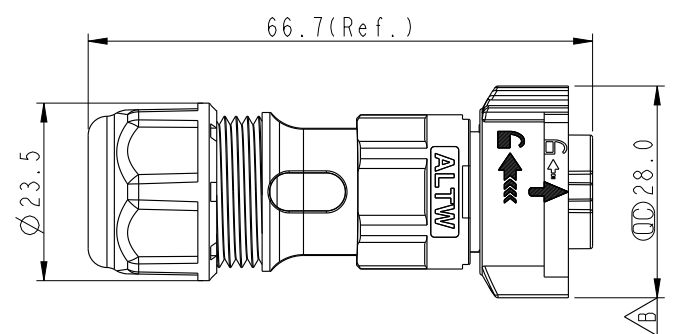
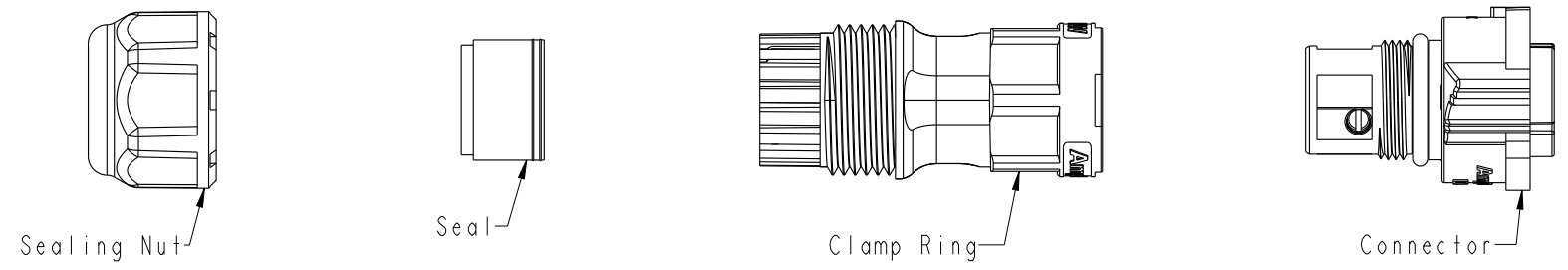

CC-XXBFFB-QL8XPP

02-2Pin  
03-3Pin

S: With Red Color Seal 1, Cable OD 6.0~8.0mm.  
M: With Yellow Color Seal 2, Cable OD 8.0~10.0mm.  
L: With Blue Color Seal 3, Cable OD 10.0~12.0mm.  
A: With Seal 1 & Seal 2 & Seal 3.

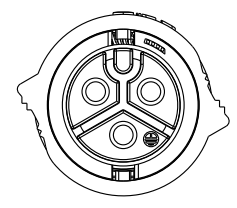
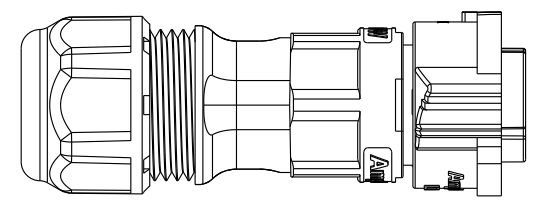

- $\triangle C$   $\triangle B$  Note:
- \*  $\varnothing$  Important Dimension
  - \* Waterproof Rate: IP68, Mated  
IP68 : 1M Depth Of Water In 24hours
  - \* Housing: Thermoplastic, Black
  - \* Pin: Copper Alloy, Silver Plated
  - \* Clamp Ring: Thermoplastic, Black
  - \* Sealing Nut: Thermoplastic, Black
  - \* Seals: Rubber

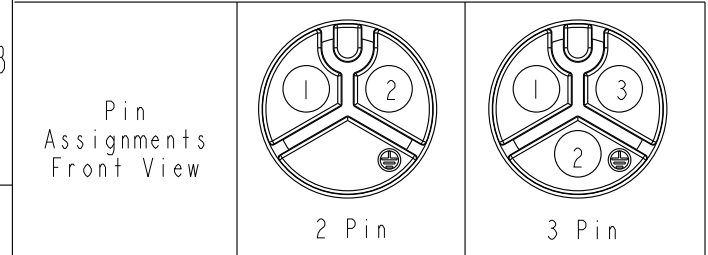

UNIT:mm		TITLE	XLOK, C-20A, 02P, CABLE W/O SR F, F, FI SCREW IN, XLOK	
TOLERANCE	$\pm 0.5$ mm	SCALE	8:5	SIZE A4
		REV.	C	WC-REV. A.3
				$\varnothing$ : Inspection item

**Amphenol LTW**  
安費諾亮泰企業股份有限公司

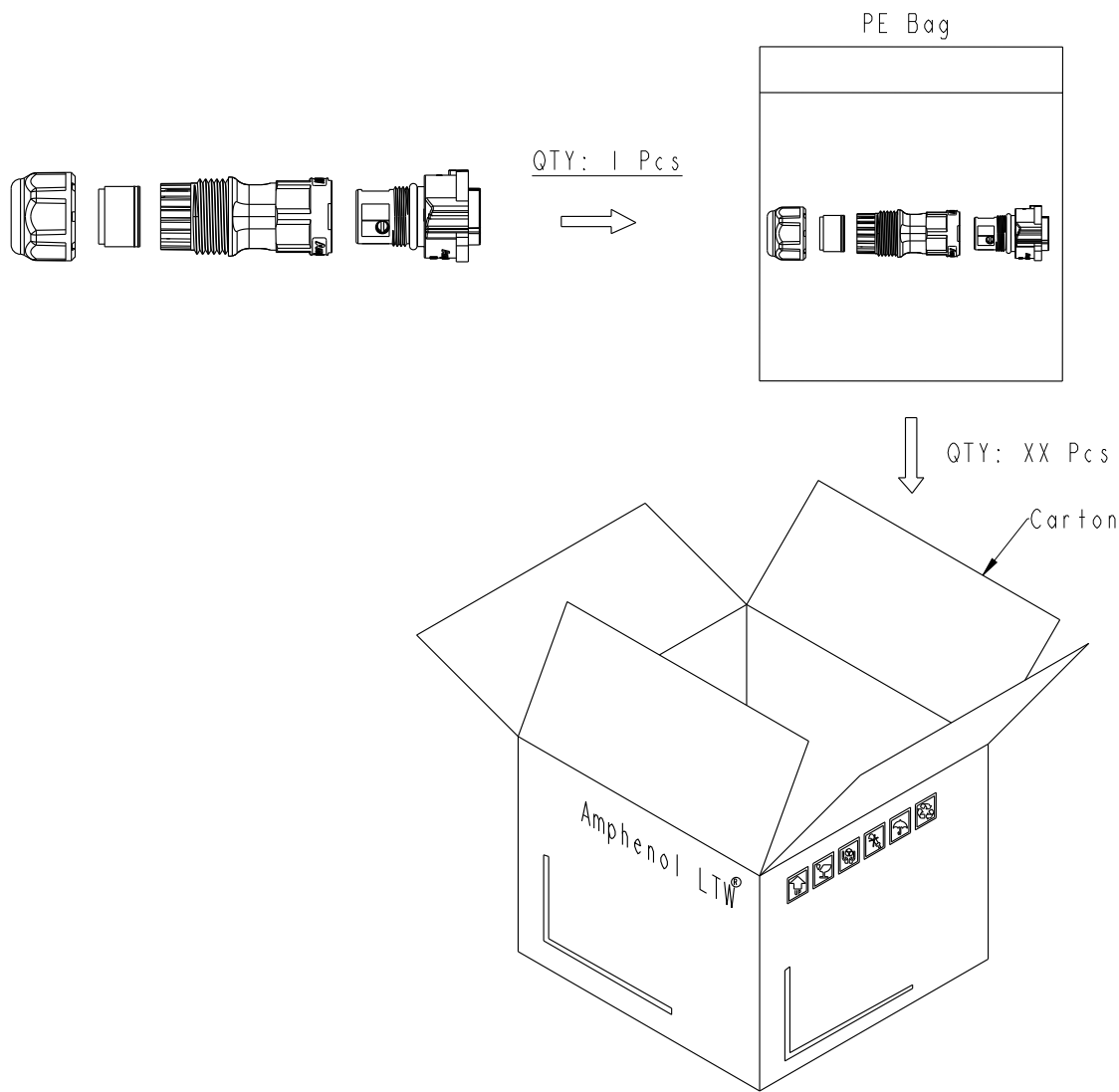

ITEM NO	CC-XXBFFB-QL8XPP	DRAWN BY	Mafei	DATE	2018-06-20
DWG NO	CC-XXBFFB-QL8XPP	CHECKED BY	Jerry	DATE	2018-06-20
CUSTOMER	ALTW	APPROVED BY	Max	DATE	2018-06-20

THIS DOCUMENT IS SUBJECT TO CHANGE WITHOUT NOTICE. IT IS CONFIDENTIAL AND A PROPERTY OF Amphenol LTW. DISCLOSURE TO THIRD PARTY HAS TO BE AUTHORIZED BY Amphenol LTW.



Note:  
 \* One Set Unassembled In One PE Bag.  
 (每一組未組裝，放置於一個PE袋，並封口，如圖示)  
 \* Label is Attached To PE Bag Front.  
 (標籤貼在PE袋正面)

UNIT:mm   
 TOLERANCE  
 ±0.5 mm

TITLE XLOK, C-20A, 02P, CABLE W/O SR  
 F, F, FI SCREWIN, XLOK   
 SCALE 8:5 SIZE A4 SHEET 2 OF 2  
 REV. C WC-REV. A.3 :Inspection item

**Amphenol LTW**  
 安費諾亮泰企業股份有限公司

ITEM NO	DRAWN BY Mafei	DATE 2018-03-14
DWG NO CC-XXBFFB-QL8XPP	CHECKED BY Jerry	DATE 2018-03-14
CUSTOMER ALTW	APPROVED BY Max	DATE 2018-03-14