

THIS DOCUMENT IS SUBJECT TO CHANGE WITHOUT NOTICE. IT IS CONFIDENTIAL AND A PROPERTY OF Amphenol LTW. DISCLOSURE TO THIRD PARTY HAS TO BE AUTHORIZED BY Amphenol LTW.

REV.	ECN NO.	DATE	SIGN	DESCRIPTION
F	C210786	2021/06/06	Angel Chou	$\triangle F$ X5
G	C220464	2022/04/07	Ruru	$\triangle G$ X4
H	C230119	2023/02/08	Vicky	$\triangle H$ X1

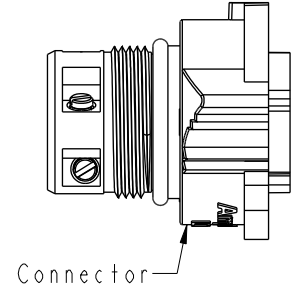
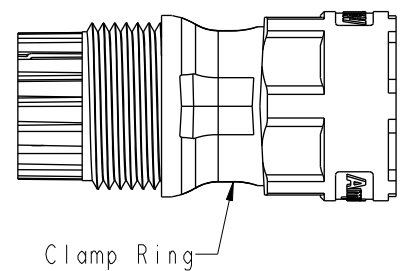
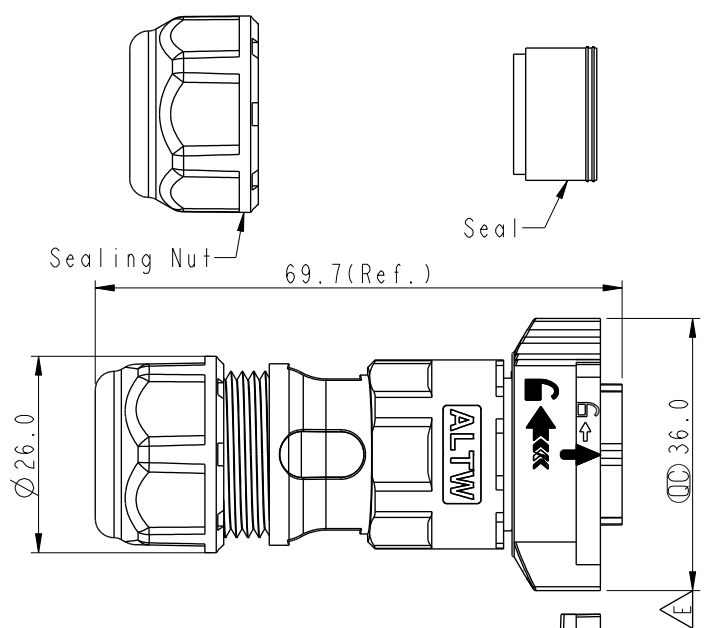

DC-XXBFFB-QL8XPP
 $\triangle C$ $\triangle G$
 XX: No. Of Pin

S: With Red Color Seal 1, Cable OD 8.0~10.0mm.
 M: With Yellow Color Seal 2, Cable OD 10.0~12.0mm.
 L: With Blue Color Seal 3, Cable OD 12.0~14.0mm.
 A: With Seal 1 & Seal 2 & Seal 3.

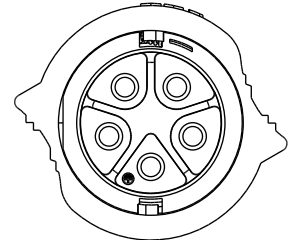
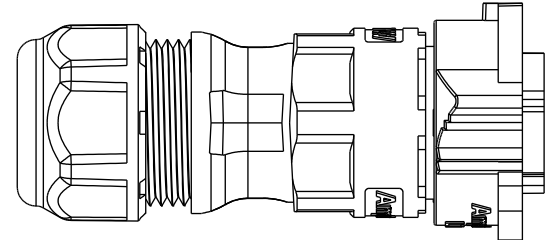

Note: $\triangle E$ $\triangle F$ $\triangle G$
 * RoHS Compliant
 * \varnothing Important dimension
 $\triangle H$ * Waterproof rate: IP68, mated 1m/24h
 * Connector
 Housing: Thermoplastic, Black
 Pin: Copper Alloy, Silver Plated
 Nut: Thermoplastic, Black
 O-Ring: Rubber, Dark Gray
 * Clamp Ring: Thermoplastic, Black
 * Sealing Nut: Thermoplastic, Black
 * Seals: Rubber

Pin Assignments Front View

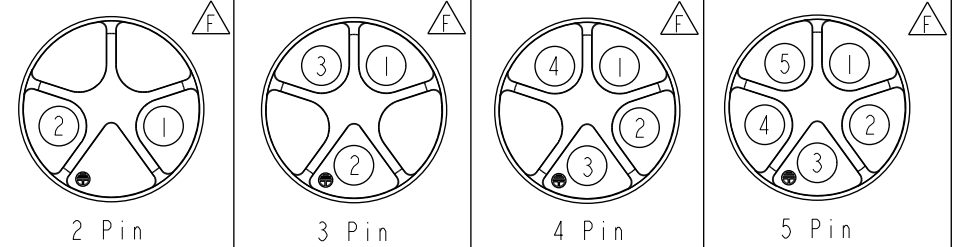

UNIT:mm	\varnothing	TITLE	XLOK, D-20A, CABLE W/O SR F, F, FI SCREW IN, PUSH LOCK	
TOLERANCE	± 0.5 mm	SCALE	8:5	SIZE A4
		REV.	H	WC-REV. A.3
		SHEET	1	OF 2
		\varnothing	Inspection item	

Amphenol LTW
 安費諾亮泰企業股份有限公司

ITEM NO	DC-XXBFFB-QL8XPP	DRAWN BY	Siou	DATE	2019-08-02
DWG NO	DC-XXBFFB-QL8XPP	CHECKED BY	Eagle	DATE	2019-08-02
CUSTOMER	ALTW	APPROVED BY	Neo	DATE	2019-08-02

THIS DOCUMENT IS SUBJECT TO CHANGE WITHOUT NOTICE. IT IS CONFIDENTIAL AND A PROPERTY OF Amphenol LTW. DISCLOSURE TO THIRD PARTY HAS TO BE AUTHORIZED BY Amphenol LTW.

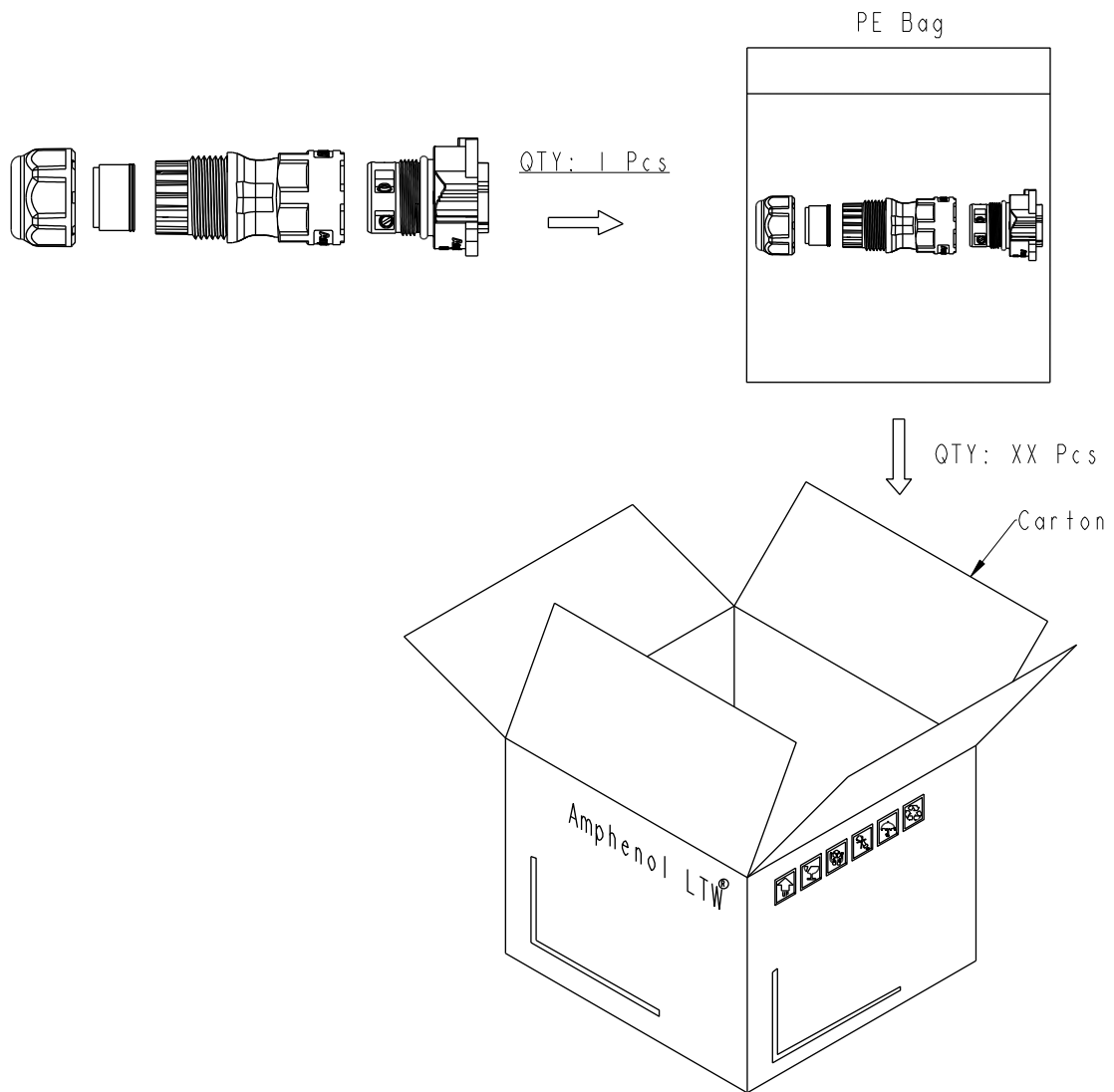

Note:
 * One Set Unassembled In One PE Bag.
 (每一組未組裝，放置於一個PE袋，並封口，如圖示)
 * Label is Attached To PE Bag Front.
 (標籤貼在PE袋正面)

UNIT:mm	
TOLERANCE	
±0.5 mm	

TITLE XLOK, D-20A, CABLE W/O SR F, F, FI SCREW IN, PUSH LOCK				
SCALE 8:5	SIZE A4	SHEET 2 OF 2		
REV. H	WC-REV. A.3	☉: Inspection item		

Amphenol LTW
 安費諾亮泰企業股份有限公司

ITEM NO	DRAWN BY Siou	DATE 2019-08-02
DWG NO DC-XXBFFB-QL8XPP	CHECKED BY Eagle	DATE 2019-08-02
CUSTOMER ALTW	APPROVED BY Neo	DATE 2019-08-02