

THIS DOCUMENT IS SUBJECT TO CHANGE WITHOUT NOTICE. IT IS CONFIDENTIAL AND A PROPERTY OF Amphenol LTW. DISCLOSURE TO THIRD PARTY HAS TO BE AUTHORIZED BY Amphenol LTW.

REV.	ECN NO.	DATE	SIGN	DESCRIPTION
A	Initial Release	2018/10/18	Mafei	Change Rev.01 To Rev.A

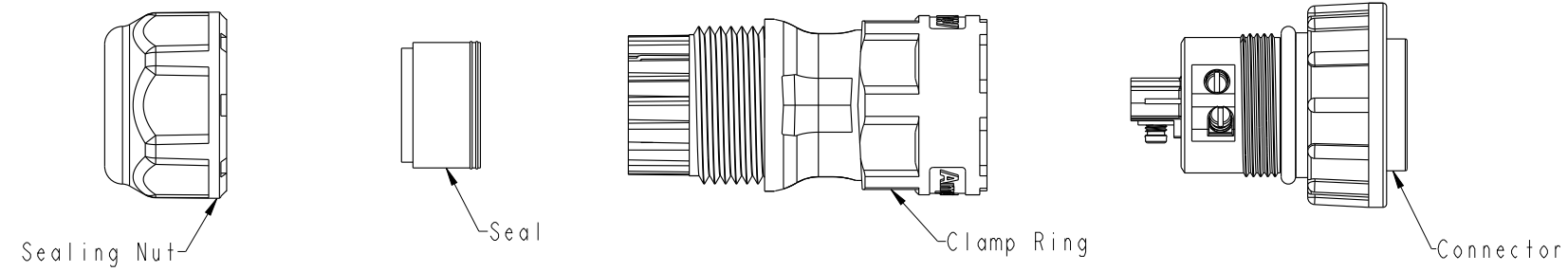

Material Specification:

- * Connector: Thermoplastic
- * Terminal: Copper Alloy, Silver Plated.
- * Gasket & O-Ring: Rubber.
- * UL Rated: UL 94V-0, fl.
- * RoHS Compliant.

Electrical Specification:

- * Contact Resistance: 10mΩ Max.
- * Insulation Resistance: 100MΩ Min.
- * Dielectric Withstand Voltage: 1,600 Vac.

Mechanical Specification:

- * Durability: 1000 Cycles.
- * Wire conductor: 14#~12#(2.0mm²~3.3mm²).
- * Wire insulation OD: Max 4.0mm.
- * Torque Force for Clamp Ring: 6~8 kgf-cm
- * Torque Force for Seal Nut: 8~15 kgf-cm
- * Torque Force for Screw: 4~5 kgf-cm

Environmental Specification:

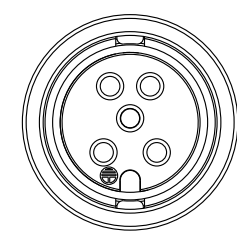
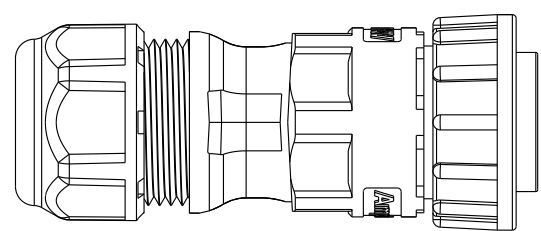
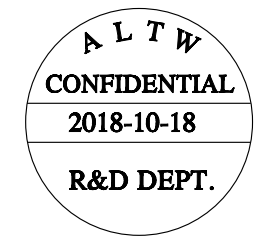
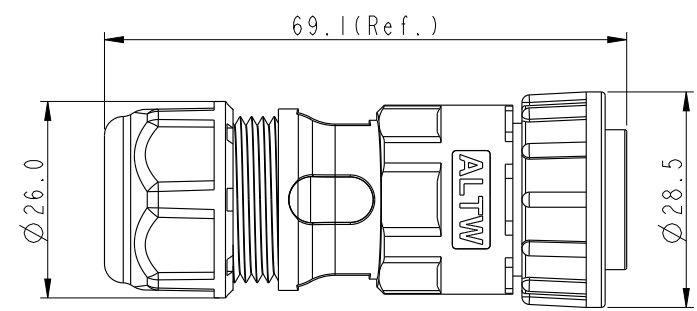

- * Waterproof Rating: IP67(Mated, 1M/30 Minutes)
- * Temperature Range: -40°C to 105°C.
- * Salt Spray: Mated, 500 Hours.
- * Safety Compliance: UL 1977.



UNIT:mm			TITLE Circular D-Size Field Installable Cable Screw-In Type F Conn F Pin		
TOLERANCE ±0.5 mm			SCALE 8:5	SIZE A4	SHEET 1 OF 2
REV. A	WC-REV. A.3	QC: Inspection item			

Amphenol LTW
安費諾亮泰企業股份有限公司

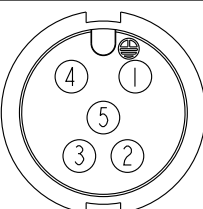
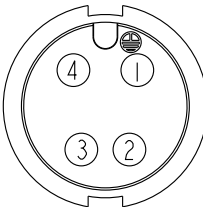
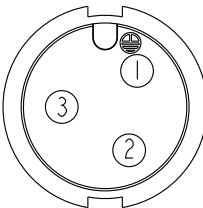
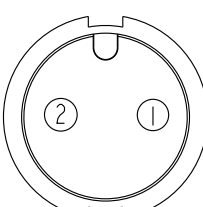
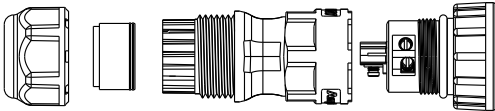
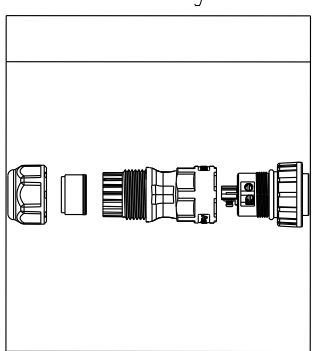
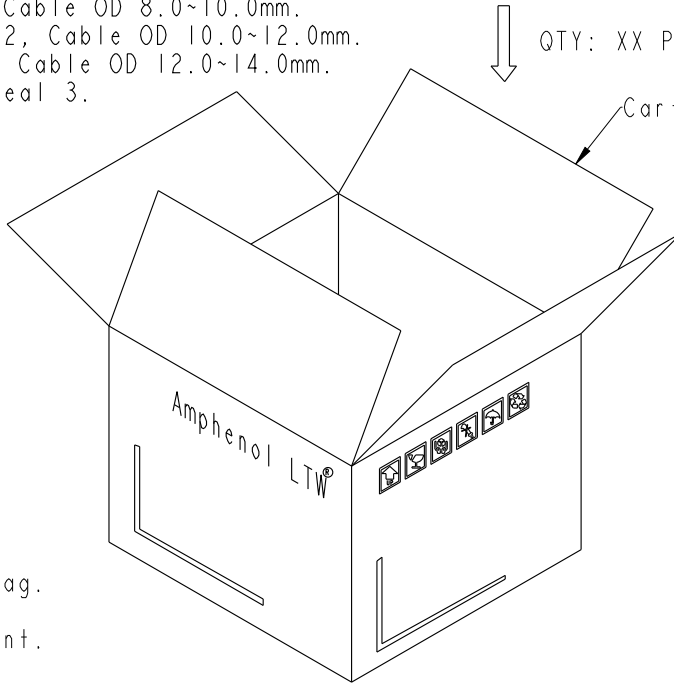
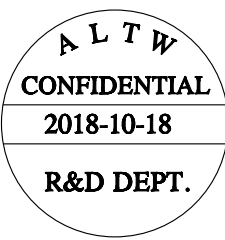
ITEM NO.	DRAWN BY Mafei	DATE 2018-10-18
DWG NO. IDC-XXBFFB-LL7XPP	CHECKED BY Jerry	DATE 2018-10-18
CUSTOMER ALTW	APPROVED BY Max	DATE 2018-10-18

F											
E	2	3	4	5	6	7	8				
D	 <p>20A ; 300Vac/Vdc 5 Contacts(05)</p>		 <p>20A ; 300Vac/Vdc 4 Contacts(04)</p>		 <p>20A ; 300Vac/Vdc 3 Contacts(03)</p>		 <p>20A ; 300Vac/Vdc 2 Contacts(02)</p>				
C			<p>Ordering Information: IDC-XXBFFB-LL7XPP</p>		<p>QTY: 1 Pcs</p> 		 <p>PE Bag</p>				
B			<p>Number of Contacts</p> <p>02 S: With Red Color Seal 1, Cable OD 8.0~10.0mm. 03 M: With Yellow Color Seal 2, Cable OD 10.0~12.0mm. 04 L: With Blue Color Seal 3, Cable OD 12.0~14.0mm. 05 A: With Seal 1 & Seal 2 & Seal 3.</p>		<p>QTY: XX Pcs</p>  <p>Carton</p>						
A											
				<p>Note:</p> <ul style="list-style-type: none"> * One Set Unassembled In One PE Bag. (每一組未組裝，放置於一個PE袋，並封口，如圖示) * Label is Attached To PE Bag Front. (標籤貼在PE袋正面) 							
<p>UNIT:mm</p>  <p>TOLERANCE ±0.5 mm</p>		<p>TITLE Circular D-Size Field Installable Cable Screw-In Type F Conn F Pin</p>		<h1>Amphenol LTW</h1> <p>安費諾亮泰企業股份有限公司</p>		<p>ITEM NO</p> <p>DWG NO IDC-XXBFFB-LL7XPP</p> <p>CUSTOMER ALTW</p>		<p>DRAWN BY Mafei</p> <p>CHECKED BY Jerry</p> <p>APPROVED BY Max</p>		<p>DATE 2018-10-18</p> <p>DATE 2018-10-18</p> <p>DATE 2018-10-18</p>	
		<p>SCALE 8:5</p> <p>REV. A</p>		<p>SIZE A4</p> <p>WC-REV. A.3</p>		<p>SHEET 2 OF 2</p> <p>QC: Inspection item</p>					
1	2	3	4	5	6	7	8				
										FMW10702-01-02A1	