

THIS DOCUMENT IS SUBJECT TO CHANGE WITHOUT NOTICE. IT IS CONFIDENTIAL AND A PROPERTY OF Amphenol LTW. DISCLOSURE TO THIRD PARTY HAS TO BE AUTHORIZED BY Amphenol LTW.

REV.	ECN NO.	DATE	SIGN	DESCRIPTION
A	Initial Release	2018/10/18	Mafei	Change Rev.02 To Rev.A

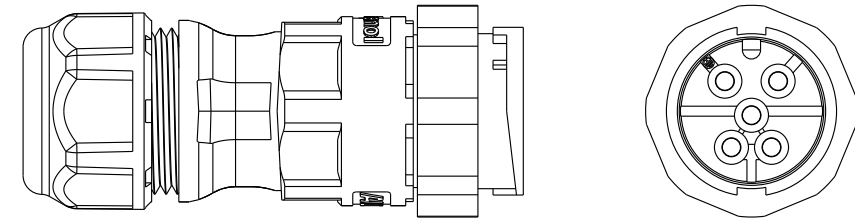
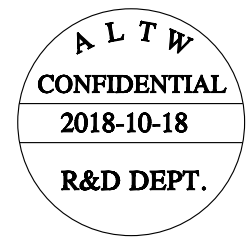
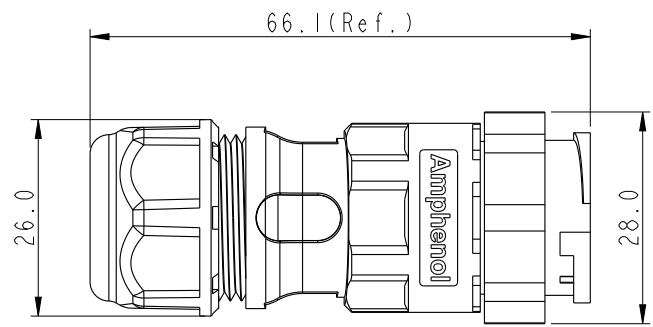
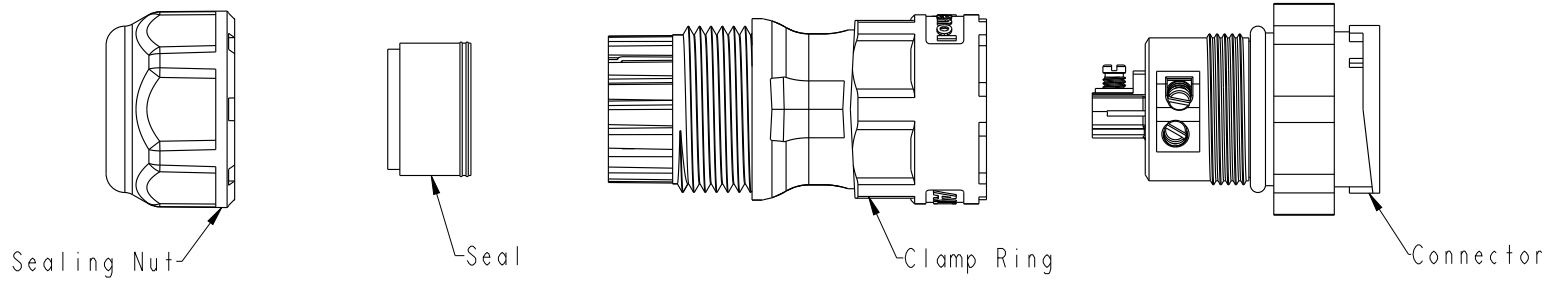

**Material Specification:**

- \* Connector: Thermoplastic
- \* Terminal: Copper Alloy, Silver Plated.
- \* Gasket & O-Ring: Rubber.
- \* UL Rated: UL 94V-0, fl.
- \* RoHS Compliant.

**Electrical Specification:**

- \* Contact Resistance: 10mΩ Max.
- \* Insulation Resistance: 100MΩ Min.
- \* Dielectric Withstand Voltage: 1,600 Vac.

**Mechanical Specification:**

- \* Durability: 1000 Cycles.
- \* Wire conductor: 14#~12#(2.0mm<sup>2</sup>~3.3mm<sup>2</sup>).
- \* Wire insulation OD: Max 4.0mm.
- \* Torque Force for Clamp Ring: 6~8 kgf-cm
- \* Torque Force for Seal Nut: 8~15 kgf-cm
- \* Torque Force for Screw: 4~5 kgf-cm







**Environmental Specification:**

- \* Waterproof Rating: IP67(Mated, 1M/30 Minutes)
- \* Temperature Range: -40°C to 105°C.
- \* Salt Spray: Mated, 500 Hours.
- \* Safety Compliance: UL 1977.

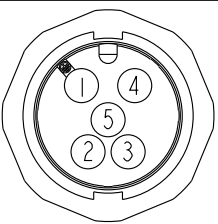
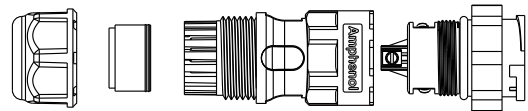
UNIT:mm			TITLE Circular D-Size Field Installable Cable Screw-In Type M Conn M Pin
TOLERANCE ±0.5 mm		SCALE 8:5	SIZE A4
REV. A	WC-REV. A.3	SHEET 1	OF 2
Inspection item			

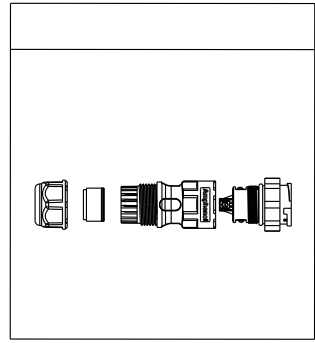
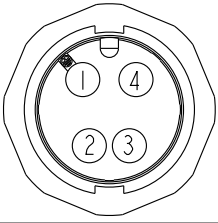
**Amphenol LTW**  
安費諾亮泰企業股份有限公司

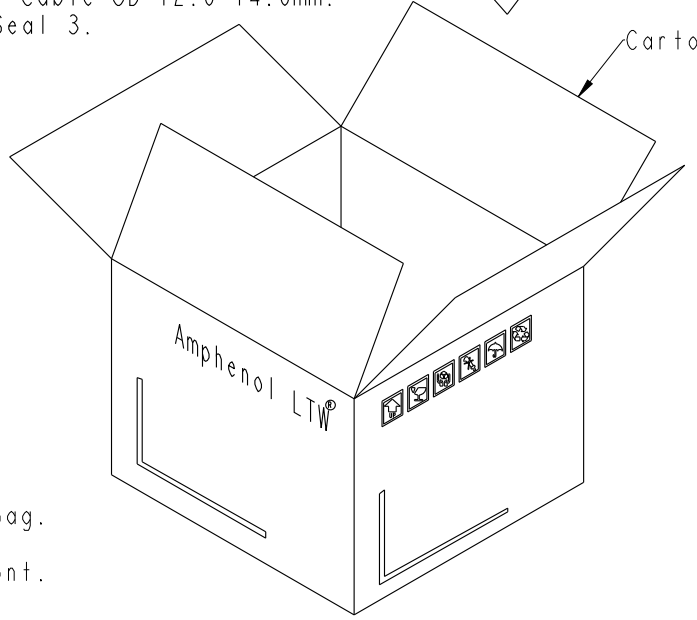
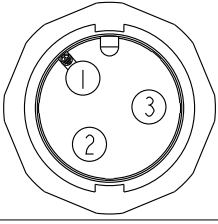
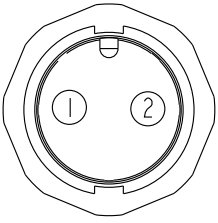
ITEM NO	DRAWN BY Mafei	DATE 2018-10-18
DWG NO IDC-XXBMMB-LL7XPP	CHECKED BY Jerry	DATE 2018-10-18
CUSTOMER ALTW	APPROVED BY Max	DATE 2018-10-18

F											
E	2	3	4	5	6	7	8				
D	 <p>20A ; 300Vac/Vdc 5 Contacts(05)</p>		 <p>Ordering Information: IDC-XXBMMB-LL7XPP</p> <p>Number of Contacts</p> <ul style="list-style-type: none"> <li>02 S: With Red Color Seal 1, Cable OD 8.0~10.0mm.</li> <li>03 M: With Yellow Color Seal 2, Cable OD 10.0~12.0mm.</li> <li>04 L: With Blue Color Seal 3, Cable OD 12.0~14.0mm.</li> <li>05 A: With Seal 1 &amp; Seal 2 &amp; Seal 3.</li> </ul>		<p>QTY: 1 Pcs</p> 	 <p>PE Bag</p>					
C	 <p>20A ; 300Vac/Vdc 4 Contacts(04)</p>						<p>QTY: XX Pcs</p> 	 <p>Carton</p>			
B	 <p>20A ; 300Vac/Vdc 3 Contacts(03)</p>										
A	 <p>20A ; 300Vac/Vdc 2 Contacts(02)</p>		<p>Note:</p> <ul style="list-style-type: none"> <li>* One Set Unassembled In One PE Bag. (每一組未組裝，放置於一個PE袋，並封口，如圖示)</li> <li>* Label is Attached To PE Bag Front. (標籤貼在PE袋正面)</li> </ul>								
<p>UNIT:mm</p>  <p>TOLERANCE ±0.5 mm</p>		<p>TITLE Circular D-Size Field Installable Cable Screw-In Type M Conn M Pin</p>		<h1 style="margin: 0;">Amphenol LTW</h1> <p style="margin: 0;">安費諾亮泰企業股份有限公司</p>		<p>ITEM NO</p> <p>DWG NO IDC-XXBMMB-LL7XPP</p> <p>CUSTOMER ALTW</p>		<p>DRAWN BY Mafei</p> <p>CHECKED BY Jerry</p> <p>APPROVED BY Max</p>		<p>DATE 2018-10-18</p> <p>DATE 2018-10-18</p> <p>DATE 2018-10-18</p>	
		<p>SCALE 8:5</p> <p>REV. A</p>		<p>SIZE A4</p> <p>WC-REV. A.3</p>		<p>SHEET 2 OF 2</p> <p>☉: Inspection item</p>				<p>8 FMW10702-01-02A1</p>	