

X-Lok Series

Mini Size

Alternative Solution to M12

Push Lock Design

Plastic and Metal **NEW**

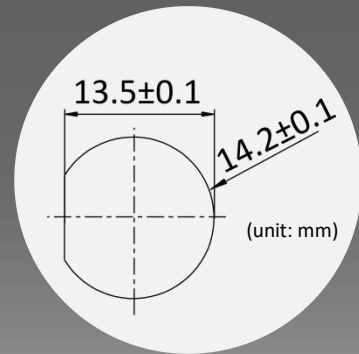

- Blind mating & audio feedback
- Salt spray up to 1000h (mated)
- EMC shielding (stainless steel available)
- Power AC/DC, data, signal or hybrid
- Up to 33 contacts / high speed data transmission
- Robust, secure and reliable for harsh environments

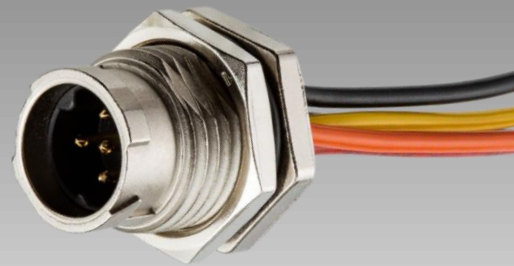

Amphenol LTW

X-Lok Push Lock Series

Blind Mating & Audio Feedback

Product Overview

Amphenol LTW's X-Lok Series connectors available in metal or plastic are presented in various sizes for power, data, signal or hybrid for fast, robust, simple, secure and reliable connections. Featuring a push lock mechanism for intuitive mating with audible and tactile feedback.

The X-Lok Series are foolproof, intuitive and enable quicker installation than traditional threaded solutions. With UL1977 & 2238+50e certification, ALTW's X-Lok is your ideal solution for outdoor applications.

Panel cut out:

(unit: mm)

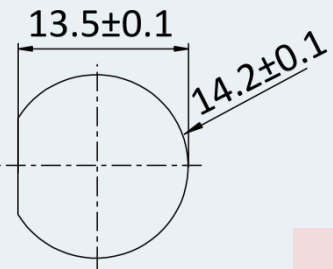
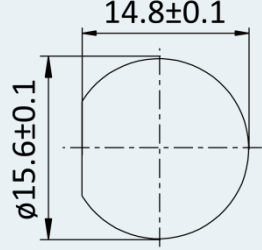
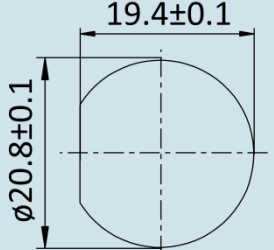
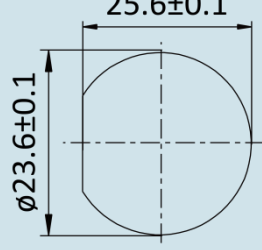
 <p>13.5±0.1 14.2±0.1</p> <p>up to 33 pins</p> <p>Mini Size</p>	 <p>14.8±0.1 ø15.6±0.1</p> <p>up to 8 pins</p> <p>Standard Size</p>
 <p>19.4±0.1 ø20.8±0.1</p> <p>up to 12 pins</p> <p>Middle Size</p>	 <p>25.6±0.1 ø23.6±0.1</p> <p>up to 100 pins</p> <p>Large Size</p>

Amphenol LTW

X-Lok Push Lock Series

Robust Mechanical Design

Applications

- LED
- Industrial automation
- Heavy equipment
- Railway mass transit
- Renewable energies
- Hybrid electric vehicles
- Medical
- Lifts and materials handling
- Broadband wireless access
- Transportation
- Remote video response center
- Marine Electronics
- Autonomous Vehicles
- Automotive diagnostics
- Automated meter reading
- Test and measurement equipment
- Rugged IT

[Catalogue](#)



Amphenol LTW

X-Lok Push Lock Series | Mini Size

Alternative Solution to M12



Features

- Blind mate, easy plug and unplug
- Plastic and metal (shielded/non-shielded)
- Stainless steel available
- Contact density up to 33 contacts
- Power AC/DC, data, signal or hybrid
- Nominal current 0.5A ~ 16A, rated voltage up to 630V
- High data transmission up to 10 Gbps
- Long service life $\geq 1,000$ cycles
- Salt spray (mated): plastic 1,000h, metal 96h
- Support overmolded with LED indicators
- Saving on-site installation time & costs
- Exponentially increase installation outputs
- Ingress protection IP68
- Receptacle (with wires), overmolded, field installable, accessories



Unrivaled InterConnects for Harsh Environments

X-Lok Push Lock Series | Mini Size

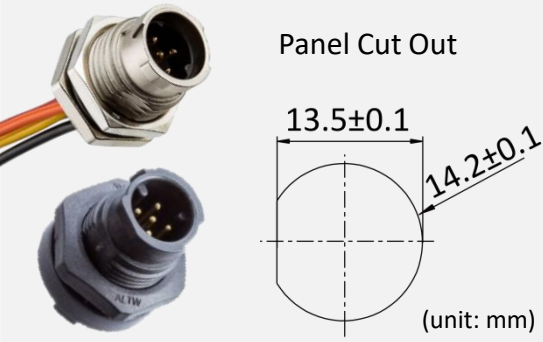
Receptacle Receptacle with Wires	Nominal Current	No of Contacts	Rated Voltage (AC/DC)	Plastic	Metal
 <p>Panel Cut Out</p> <p>13.5±0.1</p> <p>14.2±0.1</p> <p>(unit: mm)</p>	0.5A	18 ~ 33	50V	✓	*
	1.5A	10 ~ 17	30A	✓	*
	2A	6, 8	30 ~ 300V	✓	*
	5A	2 ~ 5	30 ~ 300V	✓	✓
	16A	3 ~ 5	30 ~ 630V	✓	✓

Overmolded (with LED Indicators)	Nominal Current	No of Contacts	Rated Voltage (AC/DC)	Plastic	Metal
	0.5A	18 ~ 33	50V	✓	*
	1.5A	10 ~ 17	30A	✓	*
	2A	6, 8	30 ~ 300V	✓	*
	5A	2 ~ 5	30 ~ 300V	✓	✓
	16A	3 ~ 5	30 ~ 630V	✓	✓

* Upon request

X-Lok Push Lock Series | Mini Size

Field Installable	Nominal Current	No of Contacts	Rated Voltage (AC/DC)	Plastic	Metal
 <ul style="list-style-type: none"> • Solder • Screw In • Crimp • Push In 	0.5A	18 ~ 33	50V	✓	*
	1.5A	10 ~ 17	30A	✓	*
	2A	6, 8	30 ~ 300V	✓	*
	5A	2 ~ 5	30 ~ 300V	✓	✓
	16A	3 ~ 5	30 ~ 630V	✓	✓

Accessories

				
L Adaptor	I Adaptor*	T Adaptor	Y Adaptor	Multi-Ports Adaptor
				
X-Lok to RJ45 Adaptor*	T Cable	Terminator*	Waterproof Cap	Contacts & Crimp Tool

* Upon request

Contact Us

Luc Kan | Sales & Marketing
Email: luc@ltw-tech.com

Customer Service
Email: sales@ltw-tech.com

Follow Us

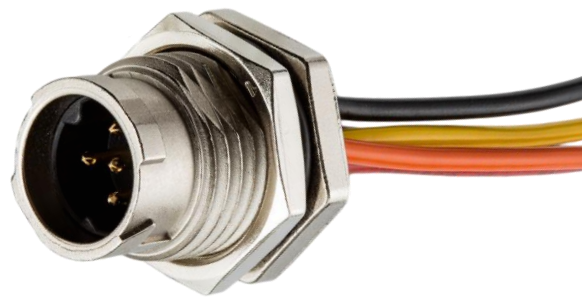
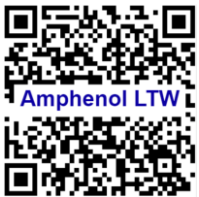

(V031022)