

REV.	ECN NO.	DATE	SIGN	DESCRIPTION
C	LEN1730327	2017/03/22	Vicky	Update Logo
D	LEN1840085	2018/04/13	Ethan	Modify Panel Thickness
E	CI90310	2019/03/12	Ruru	Modify Note

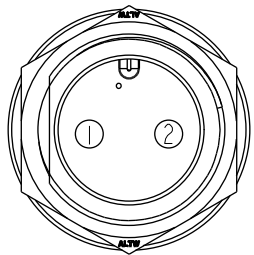

Pin Assignments
Front View

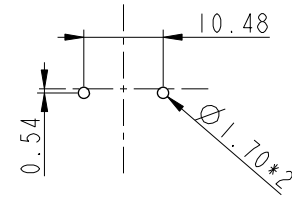
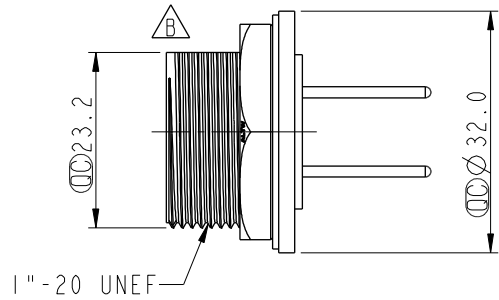

2Pin Male Connector
Male Pin PCB Layout
2Pin 公接頭
PCB控孔位置尺寸圖

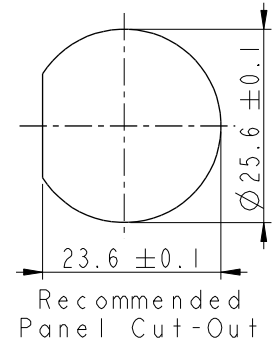

Recommended
Panel Cut-Out

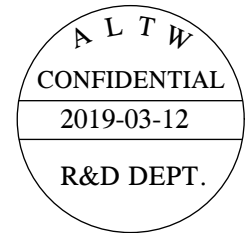
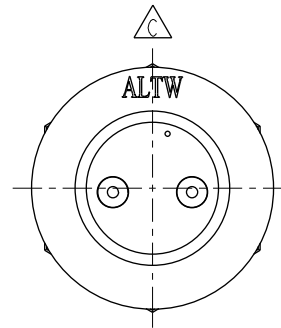
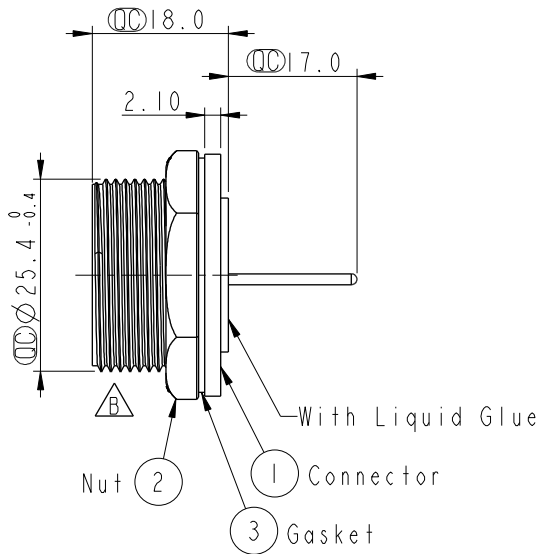
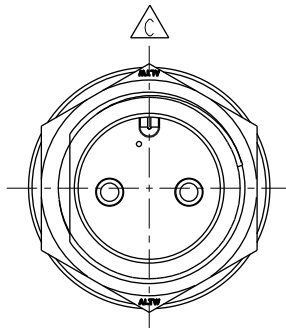

- Note:
- * Important Dimension
 - * Waterproof Rate: IP67, Unmated
 - * Housing: Thermoplastic, Black
 - * Pin: Copper Alloy, Gold Plated
 - * Nut: Thermoplastic, Black
 - * Gasket: Rubber, Black
 - * Use Waterproof Cap or Dust Cap
Panel Thickness Max: 1.8mm
 - * Use without Waterproof Cap or Dust Cap
Panel Thickness Max: 3.0mm
 - * Gasket and Nut are packed separately in PE bags.

UNIT:mm		
TOLERANCE	.X ±0.25	
	.XX ±0.1	
	.XXX ±0.05	
ANGLES	±1°	

TITLE Screw Type Connector For Panel Mount 2Pin Male Connector Male Pin(20A)			
SCALE 1:1	SIZE A4	SHEET 1 OF 1	
REV. E	WC-REV. A.3	: Inspection item	

Amphenol LTW
安費諾亮泰企業股份有限公司

ITEM NO DC-02PMMP-SC7001	DRAWN BY Ruru	DATE 2019-03-12
DWG NO DC-02PMMP-SC7001	CHECKED BY Rita	DATE 2019-03-12
CUSTOMER ALTW	APPROVED BY Max	DATE 2019-03-12

THIS DOCUMENT IS SUBJECT TO CHANGE WITHOUT NOTICE. IT IS CONFIDENTIAL AND A PROPERTY OF Amphenol LTW. DISCLOSURE TO THIRD PARTY HAS TO BE AUTHORIZED BY Amphenol LTW.