

THIS DOCUMENT IS SUBJECT TO CHANGE WITHOUT NOTICE. IT IS CONFIDENTIAL AND A PROPERTY OF Amphenol LTW. DISCLOSURE TO THIRD PARTY HAS TO BE AUTHORIZED BY Amphenol LTW.

REV.	ECN NO.	DATE	SIGN	DESCRIPTION
B	LEN-870148	2008/07/25	Yuri	Update Drawing
C	LEN1741278	2017/04/20	Vicky	Update Logo

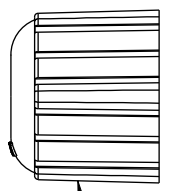

7 Sealing Nut

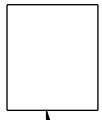

6 Seals

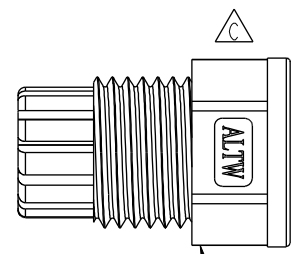

5 Clamp Ring



4 Gasket

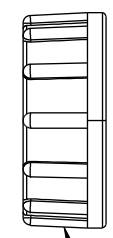

3 Lock Nut

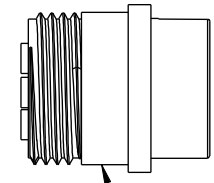

2 Connector



1 O-Ring

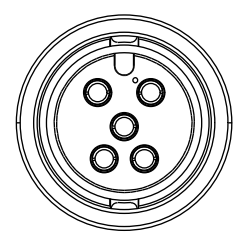
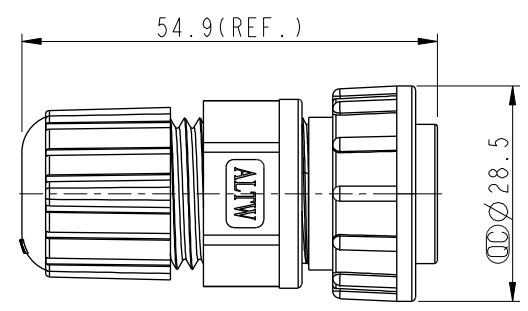

Conn.

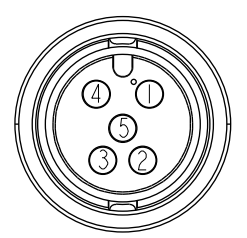

Pin Assignments  
Front View

Note:

- \*  $\varnothing$  Important Dimension
- \* Waterproof Rate: IP67
- \* Housing: Nylon+GF, Black
- \* Female Pin: Copper Alloy, Gold Plated
- \* Lock Nut: Nylon+GF, Black
- \*  $\triangle B$  Gasket: Silicone, Black
- \* O-Ring: EPDM, Black
- \* Clamp Ring: Nylon, Black
- \*  $\triangle B$  Seals: EPDM, Black
- \* Sealing Nut: Nylon, Black
- \* Seal For Cable OD:  $\varnothing$  5.5mm~10.8mm
- \* One Set Unassembled In One PE Bag

UNIT: mm		
TOLERANCE	.X $\pm 0.25$	
	.XX $\pm 0.1$	
	.XXX $\pm 0.05$	
ANGLES	$\pm 1^\circ$	

TITLE Large Assy Lock 5Pin F Conn F Pin			
SCALE 1:1	SIZE A4	SHEET 1 OF 1	
REV. C	WC-REV. A.2	$\varnothing$ : Inspection item	

**Amphenol LTW**  
安費諾亮泰企業股份有限公司

ITEM NO. DC-05BFFA-LL7001	DRAWN BY Vicky	DATE 2017-04-20
DWG NO. DC-05BFFA-LL7001	CHECKED BY Rita	DATE 2017-04-20
CUSTOMER ALTW	APPROVED BY Max	DATE 2017-04-20