

THIS DOCUMENT IS SUBJECT TO CHANGE WITHOUT NOTICE. IT IS CONFIDENTIAL AND A PROPERTY OF AMPHENOL LTW. DISCLOSURE TO THIRD PARTY HAS TO BE AUTHORIZED BY AMPHENOL LTW.

REV.	ECN NO.	DATE	SIGN	DESCRIPTION

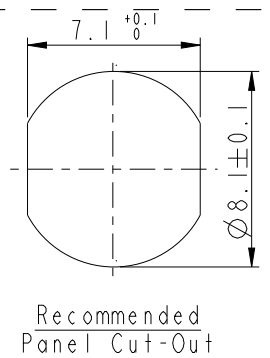
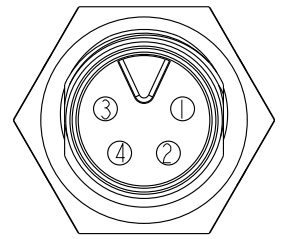
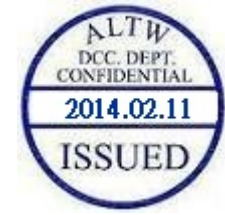
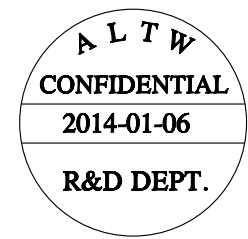
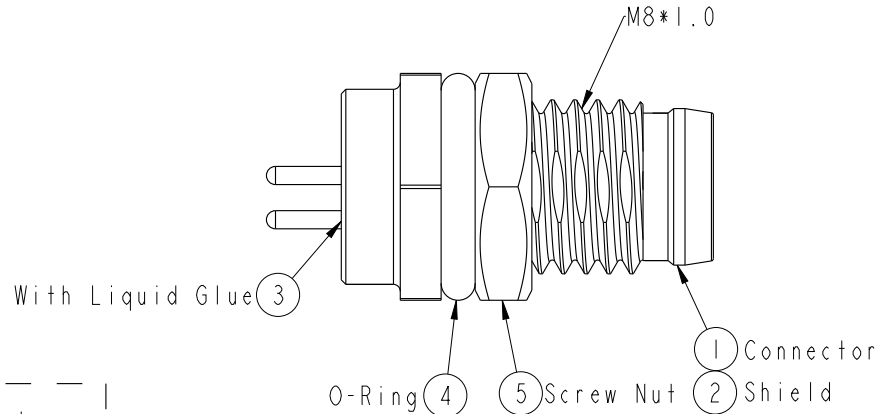
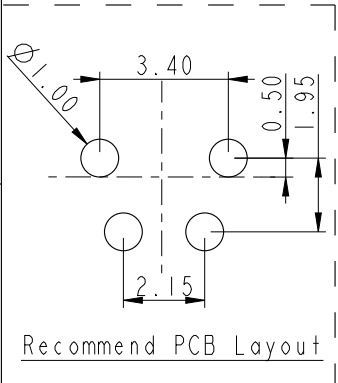
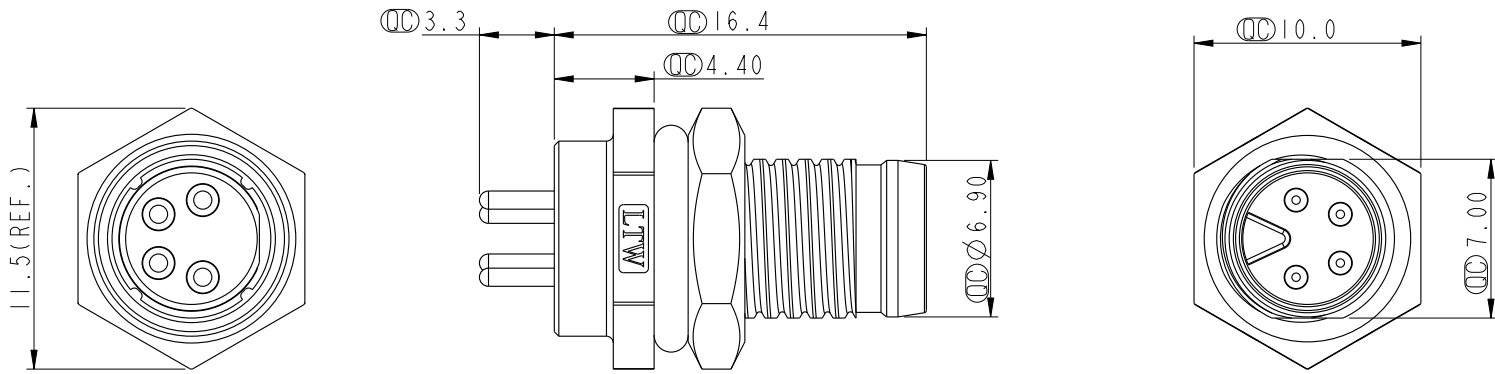

- Note:
- * ⌀ Important Dimension.
 - * Waterproof Rate: IP67.
 - * Housing: Nylon+GF, Black.
 - * Male Pin: Copper Alloy, Gold Plated.
 - * Shield: Zinc Alloy, Nickel Plated.
 - * Screw Nut: Copper Alloy, Nickel Plated.
 - * O-Ring: EPDM, Black.
 - * For Panel Thickness Max 3.0mm.
 - * Nut Torque: 4~6 kgf.cm.

UNIT:mm	
TOLERANCE	
.X	±0.25
.XX	±0.1
.XXX	±0.05
ANGLES	±1°

TITLE M8 4Pin Panel M Conn. M Pin			
SCALE 3:1	SIZE A4	SHEET 1 OF 1	
REV. A	WC-REV. A.3	⌀: Inspection item	

Amphenol LTW
安費諾亮泰企業股份有限公司

ITEM NO 8A-04PMMP-SF7001	DRAWN BY Mila	DATE 2014-01-06
DWG NO 8A-04PMMP-SF7001	CHECKED BY Jimmy	DATE 2014-01-06
CUSTOMER ALTW	APPROVED BY Jerry	DATE 2014-01-06

A B C D E F