

THIS DOCUMENT IS SUBJECT TO CHANGE WITHOUT NOTICE. IT IS CONFIDENTIAL AND A PROPERTY OF Amphenol LTW. DISCLOSURE TO THIRD PARTY HAS TO BE AUTHORIZED BY Amphenol LTW.

REV.	ECN NO.	DATE	SIGN	DESCRIPTION
B	C210625	2021/04/21	Vicky	$\triangle B$ X8
C	C221870	2022/12/01	Vicky	$\triangle C$ XI

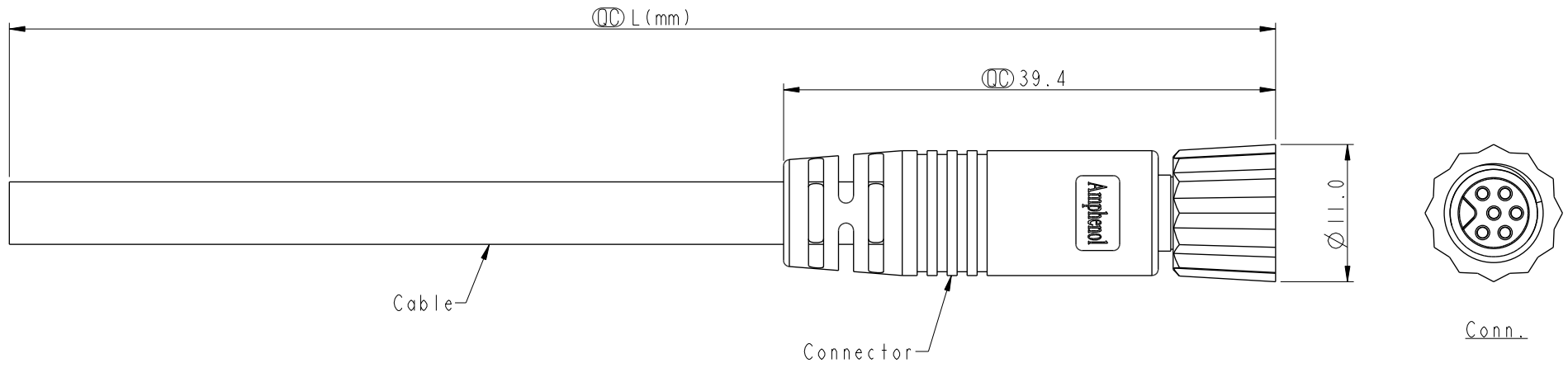

- $\triangle B$ Note:
- * RoHS Compliant
 - * $\text{\textcircled{C}}$ Important dimension
 - $\triangle C$ * Waterproof rate: IP67, mated
 - * Connector
 - Housing: Thermoplastic, Black
 - Pin: Copper alloy, Gold plated
 - O-Ring: Rubber, Green
 - Nut: Thermoplastic, Black
 - Outer mold: Thermoplastic, Black
 - * Cable: UL2464, PVC Jacket, Black
 - * Cable length tolerance: 1M: +50/-0 mm
 - 1M < L ≤ 3M: +100/-0 mm
 - 3M < L ≤ 5M: +150/-0 mm
 - 5M < L ≤ 10M: ±100 mm
 - 10M < L ≤ 20M: ±200 mm
 - 20M < L ≤ 30M: ±300 mm
 - 30M < L ≤ 99M: ±500 mm

UNIT: mm			TITLE O SEN, M8 W/KEY-PLASTIC CABLE W/SR, F, F, MOLDING	$\triangle B$
TOLERANCE	±0.5mm		SCALE 2:1	SIZE A4
	REV. C	WC-REV. A.4	SHEET 1 OF 2	$\text{\textcircled{C}}$: Inspection item

Amphenol LTW
安費諾亮泰企業股份有限公司

ITEM NO	DRAWN BY	DATE
DWG NO $\triangle B$ 8AP-XXAFFM-SL7AXX	Mila	2014-01-09
CUSTOMER	CHECKED BY	DATE
ALTW	Jimmy	2014-01-09
	APPROVED BY	DATE
	Jerry	2014-01-09

THIS DOCUMENT IS SUBJECT TO CHANGE WITHOUT NOTICE. IT IS CONFIDENTIAL AND A PROPERTY OF AMPHENOL LTW. DISCLOSURE TO THIRD PARTY HAS TO BE AUTHORIZED BY AMPHENOL LTW.

 8AP-XXAFFM-SL7AXX XX: No. Of Pin									<table border="1" style="width: 100%; border-collapse: collapse;"> <tr> <td style="width: 15%;">6P</td> <td rowspan="3" style="width: 15%; text-align: center;">5.0</td> <td rowspan="3" style="width: 15%; text-align: center;">24</td> <td style="width: 55%;">8AP-06AFFM-SL7AXX</td> </tr> <tr> <td>5P</td> <td>8AP-05AFFM-SL7AXX</td> </tr> <tr> <td>4P</td> <td>8AP-04AFFM-SL7AXX</td> </tr> <tr> <td>3P</td> <td rowspan="2" style="text-align: center;">4.2</td> <td rowspan="2" style="text-align: center;">22</td> <td>8AP-03AFFM-SL7AXX</td> </tr> <tr> <td>2P</td> <td>8AP-02AFFM-SL7AXX</td> </tr> <tr> <td>Contacts</td> <td>Cable OD</td> <td>AWG</td> <td>Item No.</td> </tr> </table>	6P	5.0	24	8AP-06AFFM-SL7AXX	5P	8AP-05AFFM-SL7AXX	4P	8AP-04AFFM-SL7AXX	3P	4.2	22	8AP-03AFFM-SL7AXX	2P	8AP-02AFFM-SL7AXX	Contacts	Cable OD	AWG	Item No.
6P	5.0	24	8AP-06AFFM-SL7AXX																								
5P			8AP-05AFFM-SL7AXX																								
4P			8AP-04AFFM-SL7AXX																								
3P	4.2	22	8AP-03AFFM-SL7AXX																								
2P			8AP-02AFFM-SL7AXX																								
Contacts	Cable OD	AWG	Item No.																								
XX: 01~99Meters 01: 01Meter 02: 02Meters . 99: 99Meters																											

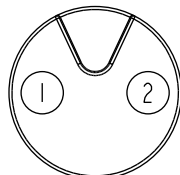
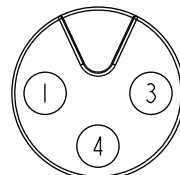
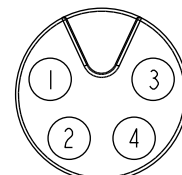
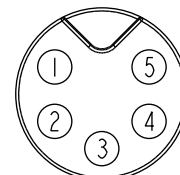
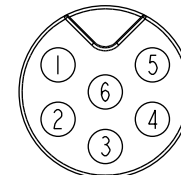
	2 Red 紅 1 Black 黑	4 Black 黑 3 Blue 藍 1 Brown 棕	4 Black 黑 3 Blue 藍 2 White 白 1 Brown 棕	5 Yellow 黃 4 Orange 橘 3 Red 紅 2 Brown 棕 1 Black 黑	6 Green 綠 5 Yellow 黃 4 Orange 橘 3 Red 紅 2 Brown 棕 1 Black 黑
Pin Out	Pin # Wire	Pin # Wire	Pin # Wire	Pin # Wire	Pin # Wire
Conn.					
	2P	3P	4P	5P	6P

 Pin Assignments Front View

UNIT: mm		TITLE O SEN, M8 W/KEY-PLASTIC CABLE W/SR, F, F, MOLDING		ITEM NO	DRAWN BY Mila	DATE 2014-01-09
TOLERANCE ±0.5mm	SCALE 2:1	SIZE A4	SHEET 2 OF 2	DWG NO  8AP-XXAFFM-SL7AXX	CHECKED BY Jimmy	DATE 2014-01-09
	REV. C	WC-REV. A.4	 Inspection item	CUSTOMER ALTW	APPROVED BY Jerry	DATE 2014-01-09
						8 W10814-03-001A2

Amphenol LTW

安費諾亮泰企業股份有限公司