

THIS DOCUMENT IS SUBJECT TO CHANGE WITHOUT NOTICE. IT IS CONFIDENTIAL AND A PROPERTY OF Amphenol LTW. DISCLOSURE TO THIRD PARTY HAS TO BE AUTHORIZED BY Amphenol LTW.

REV.	ECN NO.	DATE	SIGN	DESCRIPTION
G	C210020	2021/01/07	Vicky	$\triangle G$ XI
H	C210221	2021/03/18	Vicky	$\triangle H$ X4
I	C221993	2022/12/26	Vicky	$\triangle I$ XI

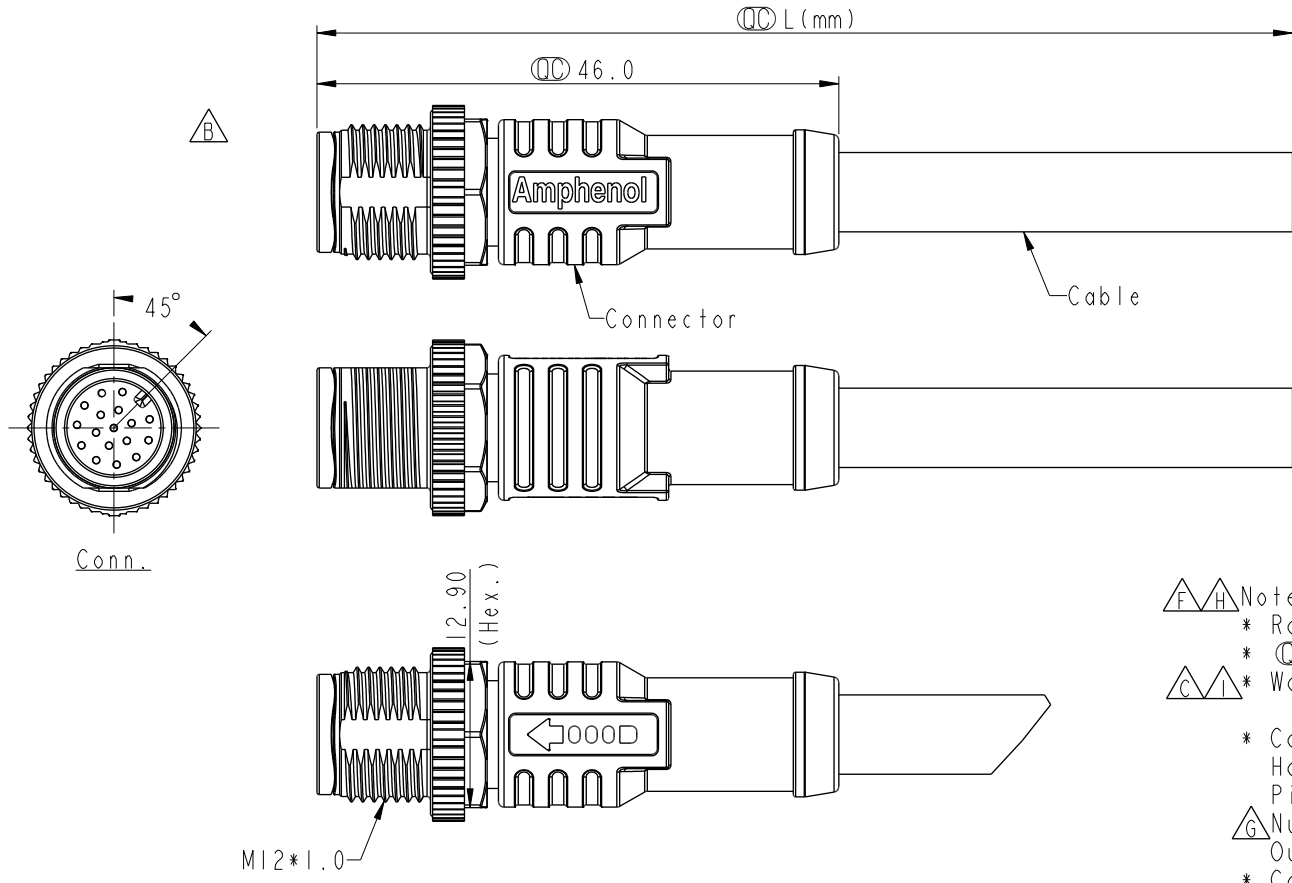

- $\triangle F \triangle H$  Note:
- \* RoHS Compliant
  - \*  $\text{\textcircled{C}}$  Important dimension
  - $\triangle C \triangle I$  \* Waterproof rate: IP68, mated 1m/24h  
IP69K, mated
  - \* Connector
    - Housing: Thermoplastic, Black
    - Pin: Copper alloy, Gold plated
  - $\triangle G$  Nut: Metal
    - Outer mold: Thermoplastic, Black
  - \* Cable: UL2517, PVC Jacket, Black
  - \* Cable length tolerance: IM: +50/-0 mm
    - 1M < L ≤ 3M: +100/-0 mm
    - 3M < L ≤ 5M: +150/-0 mm
    - 5M < L ≤ 10M: ±100 mm
    - 10M < L ≤ 20M: ±200 mm
    - 20M < L ≤ 30M: ±300 mm
    - 30M < L ≤ 99M: ±500 mm

UNIT: mm	$\text{\textcircled{C}}$	$\text{\textcircled{H}}$	TITLE N SEN, M12 A, SCREW CABLE W/O SR, M, M, MOLDING
TOLERANCE $\pm 0.5\text{mm}$	SCALE 3:2	SIZE A4	SHEET 1 OF 2
REV. 1	WC-REV. A.3	$\text{\textcircled{C}}$ : Inspection item	

**Amphenol LTW**  
安費諾亮泰企業股份有限公司

ITEM NO.	DRAWN BY Lingpeng	DATE 2017-04-06
DWG NO. $\triangle E$ M12A-XXBMMM-SL8DXX	CHECKED BY Ma Fei	DATE 2017-04-06
CUSTOMER ALTW	APPROVED BY Jerry	DATE 2017-04-06

THIS DOCUMENT IS SUBJECT TO CHANGE WITHOUT NOTICE. IT IS CONFIDENTIAL AND A PROPERTY OF Amphenol LTW. DISCLOSURE TO THIRD PARTY HAS TO BE AUTHORIZED BY Amphenol LTW.

 <b>M12A-XXBMMM-SL8DXX</b> XX: No. Of Pin							 17P 7.0 12P 6.0 10P 6.0 26 8P 5.5 6P 5.0 24 5P 5.1 4P 4.8 22 3P 4.5  5P 5.1 4P 4.8 22 3P 4.5  Contacts Cable OD AWG Item No.
							XX: 01~99Meters 01: 01Meter 02: 02Meters : 99: 99Meters

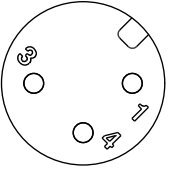
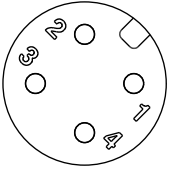
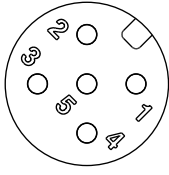
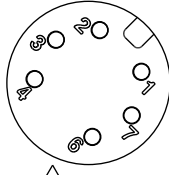
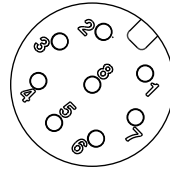
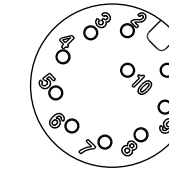
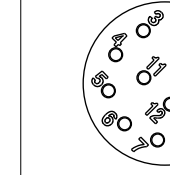
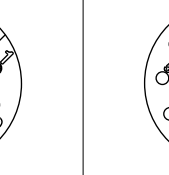
	Pin Out	5 -- 4 Black 黑 3 Blue 藍 2 -- 1 Brown 棕	5 -- 4 Black 黑 3 Blue 藍 2 White 白 1 Brown 棕	5 Gray 灰 4 Black 黑 3 Blue 藍 2 White 白 1 Brown 棕	8 -- 7 Blue 藍 6 Pink 粉 5 -- 4 Yellow 黃 3 Green 綠 2 Brown 棕 1 White 白	8 Red 紅 7 Blue 藍 6 Pink 粉 5 Gray 灰 4 Yellow 黃 3 Green 綠 2 Brown 棕 1 White 白	12 -- 11 -- 10 Violet 紫 9 Black 黑 8 Red 紅 7 Blue 藍 6 Pink 粉 5 Gray 灰 4 Yellow 黃 3 Green 綠 2 Brown 棕 1 White 白	12 Red/Blue 紅/藍 11 Gray/Pink 灰/粉 10 Violet 紫 9 Black 黑 8 Red 紅 7 Blue 藍 6 Pink 粉 5 Gray 灰 4 Yellow 黃 3 Green 綠 2 Brown 棕 1 White 白	17 White/Gray 白/灰 16 Yellow/Brown 黃/棕 15 White/Yellow 白/黃 14 Brown/Green 棕/綠 13 White/Green 白/綠 12 Red/Blue 紅/藍 11 Gray/Pink 灰/粉 10 Violet 紫 9 Red 紅 8 Gray 灰 7 Black 黑 6 Yellow 黃 5 Pink 粉 4 Green 綠 3 White 白 2 Blue 藍 1 Brown 棕
	Conn.								

Pin Assignments Front View

UNIT:mm		TITLE N SEN, M12 A, SCREW CABLE W/O SR, M, M, MOLDING		<b>Amphenol LTW</b>	ITEM NO	DRAWN BY Lingpeng	DATE 2017-04-06
TOLERANCE ±0.5mm		SCALE 3:2	SIZE A4	<b>安費諾亮泰企業股份有限公司</b>	DWG NO M12A-XXBMMM-SL8DXX	CHECKED BY Ma Fei	DATE 2017-04-06
		REV. 1	WC-REV. A.3		CUSTOMER ALTW	APPROVED BY Jerry	DATE 2017-04-06
			QC: Inspection item				