

THIS DOCUMENT IS SUBJECT TO CHANGE WITHOUT NOTICE. IT IS CONFIDENTIAL AND A PROPERTY OF Amphenol LTW. DISCLOSURE TO THIRD PARTY HAS TO BE AUTHORIZED BY Amphenol LTW.

REV.	ECN NO.	DATE	SIGN	DESCRIPTION
G	C210020	2021/01/07	Vicky	$\triangle G$ XI
H	C210221	2021/03/18	Vicky	$\triangle H$ X4
I	C221993	2022/12/26	Vicky	$\triangle I$ XI

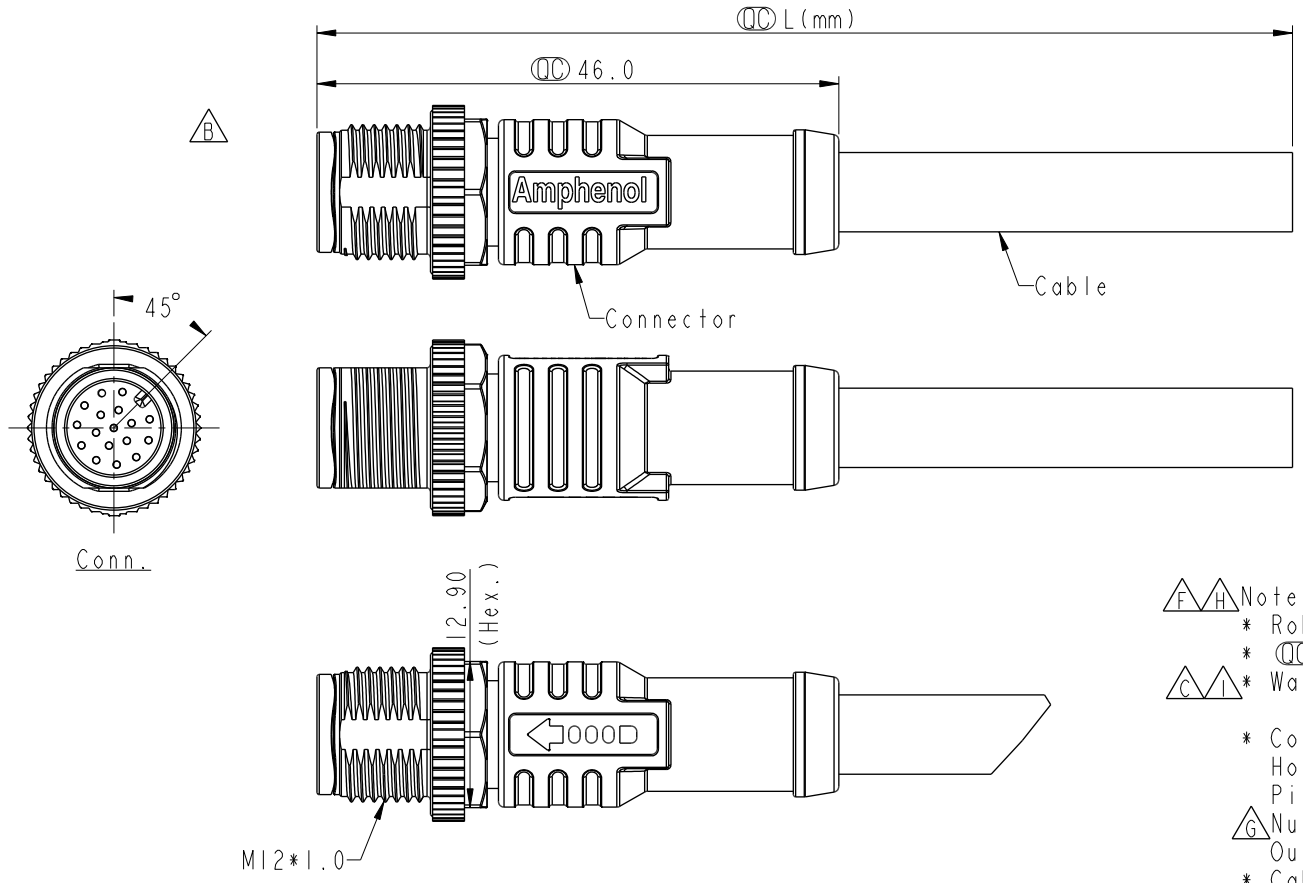





- $\triangle F \triangle H$ Note:
- * RoHS Compliant
 - * $\text{\textcircled{C}}$ Important dimension
 - * $\triangle C \triangle I$ Waterproof rate: IP68, mated 1m/24h
IP69K, mated
 - * Connector
 - Housing: Thermoplastic, Black
 - Pin: Copper alloy, Gold plated
 - * $\triangle G$ Nut: Metal
 - Outer mold: Thermoplastic, Black
 - * Cable: UL2517, PVC Jacket, Yellow
 - * Cable length tolerance: IM: +50/-0 mm
 - 1M < L ≤ 3M: +100/-0 mm
 - 3M < L ≤ 5M: +150/-0 mm
 - 5M < L ≤ 10M: ±100 mm
 - 10M < L ≤ 20M: ±200 mm
 - 20M < L ≤ 30M: ±300 mm
 - 30M < L ≤ 99M: ±500 mm

UNIT: mm	$\text{\textcircled{C}}$	$\text{\textcircled{H}}$	TITLE N SEN, M12 A, SCREW CABLE W/O SR, M, M, MOLDING
TOLERANCE $\pm 0.5\text{mm}$	SCALE 3:2	SIZE A4	SHEET 1 OF 2
REV. 1	WC-REV. A.3	$\text{\textcircled{C}}$: Inspection item	

Amphenol LTW
安費諾亮泰企業股份有限公司

ITEM NO.	DRAWN BY Lingpeng	DATE 2017-04-06
DWG NO. $\triangle E$ M12A-XXBMMM-SL8AXX	CHECKED BY Ma Fei	DATE 2017-04-06
CUSTOMER ALTW	APPROVED BY Jerry	DATE 2017-04-06

THIS DOCUMENT IS SUBJECT TO CHANGE WITHOUT NOTICE. IT IS CONFIDENTIAL AND A PROPERTY OF Amphenol LTW. DISCLOSURE TO THIRD PARTY HAS TO BE AUTHORIZED BY Amphenol LTW.

 M12A-XXBMMM-SL8AXX XX: No. Of Pin							 17P 7.0 12P 6.0 10P 6.0 8P 5.5 6P 5.0 5P 5.1 4P 4.8 3P 4.5  26 24 22  Contacts Cable OD AWG Item No.
							XX: 01~99Meters 01: 01Meter 02: 02Meters : 99: 99Meters

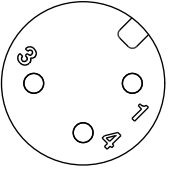
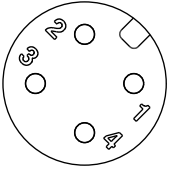
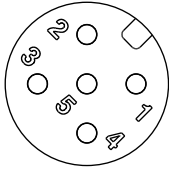
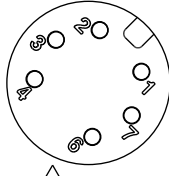
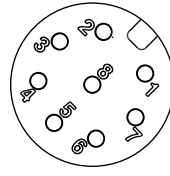
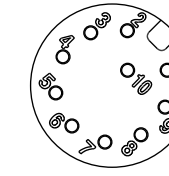
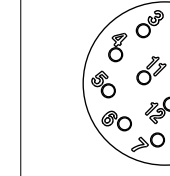
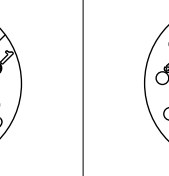
	Pin Out	5 -- 4 Black 黑 3 Blue 藍 2 -- 1 Brown 棕	5 -- 4 Black 黑 3 Blue 藍 2 White 白 1 Brown 棕	5 Gray 灰 4 Black 黑 3 Blue 藍 2 White 白 1 Brown 棕	8 -- 7 Blue 藍 6 Pink 粉 5 -- 4 Yellow 黃 3 Green 綠 2 Brown 棕 1 White 白	8 Red 紅 7 Blue 藍 6 Pink 粉 5 Gray 灰 4 Yellow 黃 3 Green 綠 2 Brown 棕 1 White 白	12 -- 11 -- 10 Violet 紫 9 Black 黑 8 Red 紅 7 Blue 藍 6 Pink 粉 5 Gray 灰 4 Yellow 黃 3 Green 綠 2 Brown 棕 1 White 白	12 Red/Blue 紅/藍 11 Gray/Pink 灰/粉 10 Violet 紫 9 Black 黑 8 Red 紅 7 Blue 藍 6 Pink 粉 5 Gray 灰 4 Yellow 黃 3 Green 綠 2 Brown 棕 1 White 白	17 White/Gray 白/灰 16 Yellow/Brown 黃/棕 15 White/Yellow 白/黃 14 Brown/Green 棕/綠 13 White/Green 白/綠 12 Red/Blue 紅/藍 11 Gray/Pink 灰/粉 10 Violet 紫 9 Red 紅 8 Gray 灰 7 Black 黑 6 Yellow 黃 5 Pink 粉 4 Green 綠 3 White 白 2 Blue 藍 1 Brown 棕
	Conn.								

Pin Assignments Front View

UNIT:mm		TITLE N SEN, M12 A, SCREW CABLE W/O SR, M, M, MOLDING		Amphenol LTW	ITEM NO	DRAWN BY Lingpeng	DATE 2017-04-06
TOLERANCE	±0.5mm	SCALE 3:2	SIZE A4	安費諾亮泰企業股份有限公司	DWG NO M12A-XXBMMM-SL8AXX	CHECKED BY Ma Fei	DATE 2017-04-06
REV.	1	WC-REV.	A.3		CUSTOMER ALTW	APPROVED BY Jerry	DATE 2017-04-06