

THIS DOCUMENT IS SUBJECT TO CHANGE WITHOUT NOTICE. IT IS CONFIDENTIAL AND A PROPERTY OF Amphenol LTW. DISCLOSURE TO THIRD PARTY HAS TO BE AUTHORIZED BY Amphenol LTW.

REV.	ECN NO.	DATE	SIGN	DESCRIPTION
G	C210020	2021/01/07	Vicky	$\triangle G$ XI
H	C210221	2021/03/18	Vicky	$\triangle H$ X4
I	C221993	2022/12/26	Vicky	$\triangle I$ XI

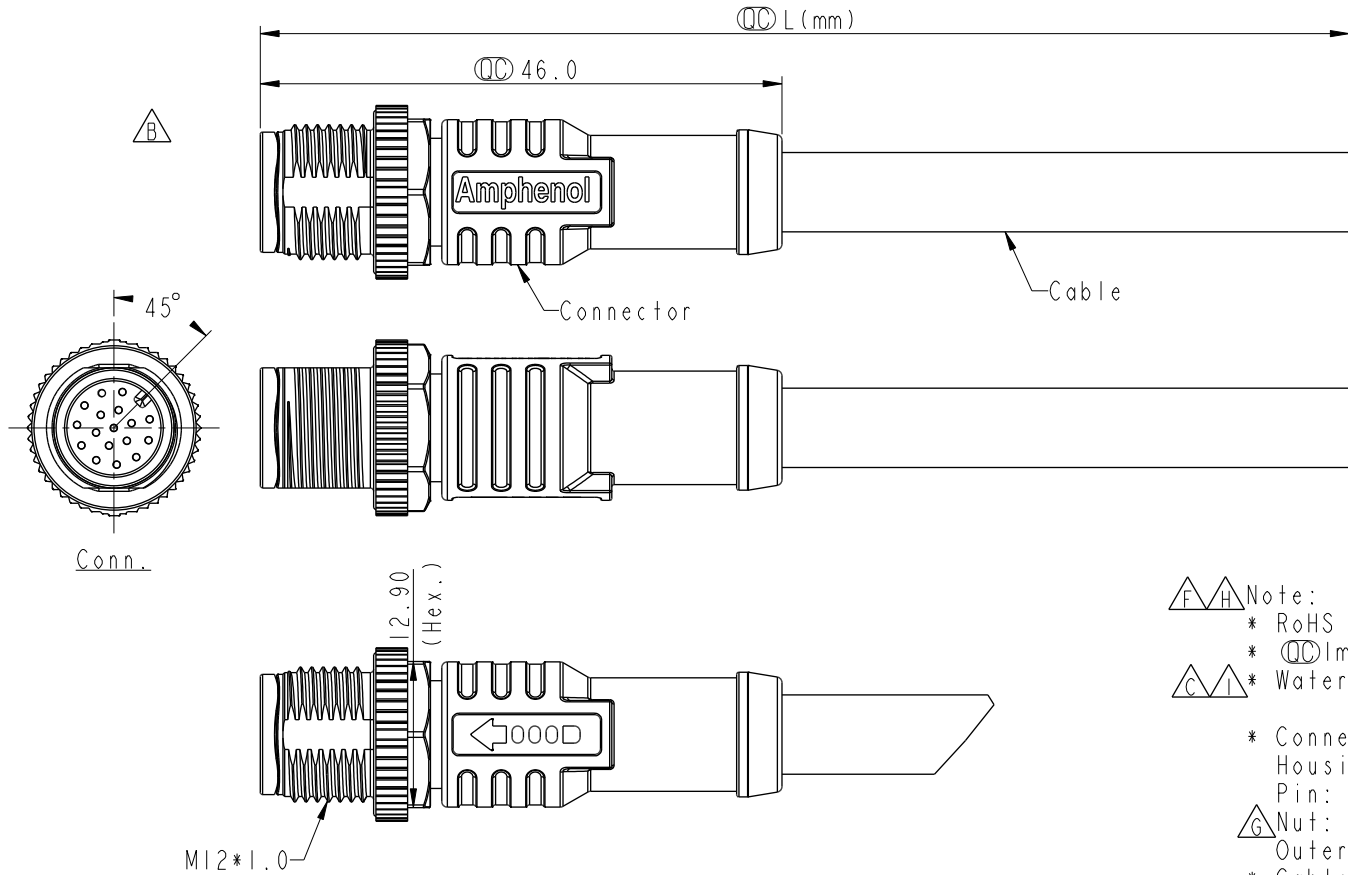

- $\triangle F \triangle H$  Note:
- \* RoHS Compliant
  - \*  $\text{CC}$  Important dimension
  - \*  $\triangle C \triangle I$  Waterproof rate: IP68, mated 1m/24h  
IP69K, mated
  - \* Connector Housing: Thermoplastic, Black  
Pin: Copper alloy, Gold plated
  - \*  $\triangle G$  Nut: Metal  
Outer mold: Thermoplastic, Black
  - \* Cable: UL20549, PUR Jacket, Black
  - \* Cable length tolerance: 1M: +50/-0 mm  
1M < L ≤ 3M: +100/-0 mm  
3M < L ≤ 5M: +150/-0 mm  
5M < L ≤ 10M: ±100 mm  
10M < L ≤ 20M: ±200 mm  
20M < L ≤ 30M: ±300 mm  
30M < L ≤ 99M: ±500 mm

UNIT: mm	$\text{CC}$	$\triangle H$	TITLE N SEN, M12 A, SCREW CABLE W/O SR, M, M, MOLDING
TOLERANCE ±0.5mm	SCALE 3:2	SIZE A4	SHEET 1 OF 2
REV. 1	WC-REV. A.3	$\text{CC}$ : Inspection item	

**Amphenol LTW**  
安費諾亮泰企業股份有限公司

ITEM NO.	DRAWN BY Lingpeng	DATE 2017-04-06
DWG NO. $\triangle E$ M12A-XXBMMM-SL8BXX	CHECKED BY Ma Fei	DATE 2017-04-06
CUSTOMER ALTW	APPROVED BY Jerry	DATE 2017-04-06

THIS DOCUMENT IS SUBJECT TO CHANGE WITHOUT NOTICE. IT IS CONFIDENTIAL AND A PROPERTY OF Amphenol LTW. DISCLOSURE TO THIRD PARTY HAS TO BE AUTHORIZED BY Amphenol LTW.

 <b>M12A-XXBMMM-SL8BXX</b> XX: No. Of Pin							 17P 12P 10P 8P 6P 5P 4P 3P Contacts	7.0 6.0 4.8 5.0 4.4 4.0 3.8 Cable OD	26 24 22	24 22	26 24 22 AWG	M12A-17BMMM-SL8BXX M12A-12BMMM-SL8BXX M12A-10BMMM-SL8BXX M12A-08BMMM-SL8BXX M12A-06BMMM-SL8BXX M12A-05BMMM-SL8BXX M12A-04BMMM-SL8BXX M12A-03BMMM-SL8BXX Item No.
XX: 01~99Meters 01: 01Meter 02: 02Meters : 99: 99Meters												

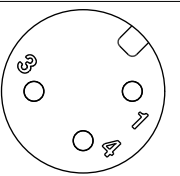
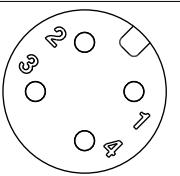
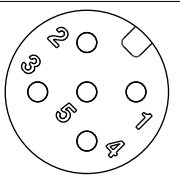
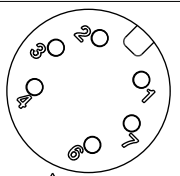
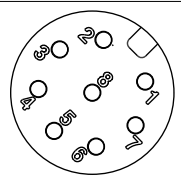
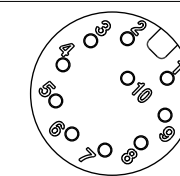
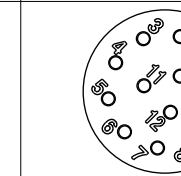
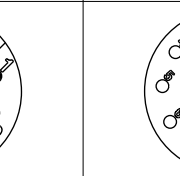
	Pin Out	5 -- 4 Black 黑 3 Blue 藍 2 -- 1 Brown 棕	5 -- 4 Black 黑 3 Blue 藍 2 White 白 1 Brown 棕	5 Gray 灰 4 Black 黑 3 Blue 藍 2 White 白 1 Brown 棕	8 -- 7 Blue 藍 6 Pink 粉 5 -- 4 Yellow 黃 3 Green 綠 2 Brown 棕 1 White 白	8 Red 紅 7 Blue 藍 6 Pink 粉 5 Gray 灰 4 Yellow 黃 3 Green 綠 2 Brown 棕 1 White 白	12 -- 11 -- 10 Violet 紫 9 Black 黑 8 Red 紅 7 Blue 藍 6 Pink 粉 5 Gray 灰 4 Yellow 黃 3 Green 綠 2 Brown 棕 1 White 白	12 Red/Blue 紅/藍 11 Gray/Pink 灰/粉 10 Violet 紫 9 Black 黑 8 Red 紅 7 Blue 藍 6 Pink 粉 5 Gray 灰 4 Yellow 黃 3 Green 綠 2 Brown 棕 1 White 白	17 White/Gray 白/灰 16 Yellow/Brown 黃/棕 15 White/Yellow 白/黃 14 Brown/Green 棕/綠 13 White/Green 白/綠 12 Red/Blue 紅/藍 11 Gray/Pink 灰/粉 10 Violet 紫 9 Red 紅 8 Gray 灰 7 Black 黑 6 Yellow 黃 5 Pink 粉 4 Green 綠 3 White 白 2 Blue 藍 1 Brown 棕	17 White/Gray 白/灰 16 Yellow/Brown 黃/棕 15 White/Yellow 白/黃 14 Brown/Green 棕/綠 13 White/Green 白/綠 12 Red/Blue 紅/藍 11 Gray/Pink 灰/粉 10 Violet 紫 9 Red 紅 8 Gray 灰 7 Black 黑 6 Yellow 黃 5 Pink 粉 4 Green 綠 3 White 白 2 Blue 藍 1 Brown 棕	
	Conn.										

Pin Assignments Front View

UNIT:mm		TITLE N SEN, M12 A, SCREW CABLE W/O SR, M, M, MOLDING		<b>Amphenol LTW</b>	ITEM NO	DRAWN BY	DATE
TOLERANCE	±0.5mm	SCALE 3:2	SIZE A4	<b>安費諾亮泰企業股份有限公司</b>	DWG NO M12A-XXBMMM-SL8BXX	Lingpeng	2017-04-06
REV. 1	WC-REV. A.3	SHEET 2 OF 2	QC: Inspection item	ALTW	CUSTOMER	Ma Fei	2017-04-06
						Jerry	2017-04-06