

THIS DOCUMENT IS SUBJECT TO CHANGE WITHOUT NOTICE. IT IS CONFIDENTIAL AND A PROPERTY OF Amphenol LTW. DISCLOSURE TO THIRD PARTY HAS TO BE AUTHORIZED BY Amphenol LTW.

REV.	ECN NO.	DATE	SIGN	DESCRIPTION
F	C210024	2021/01/08	Vicky	$\triangle F$ XI
G	C210542	2021/02/17	Ruru	$\triangle G$ X5
H	C221874	2022/12/05	Ruru	$\triangle H$ XI

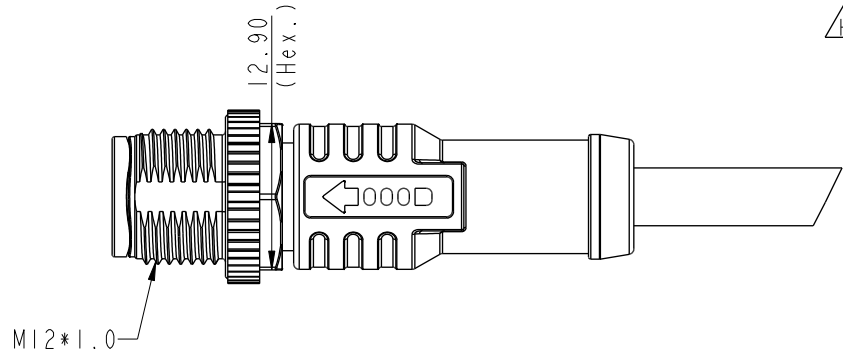
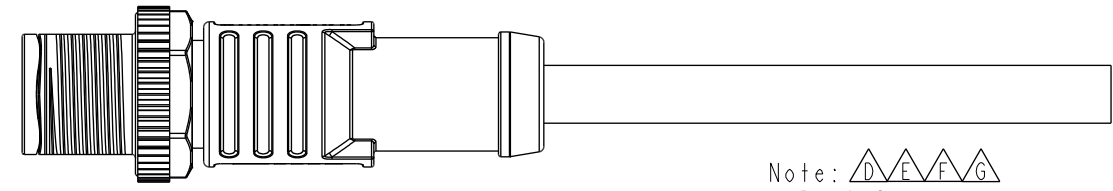
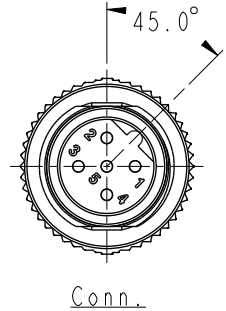
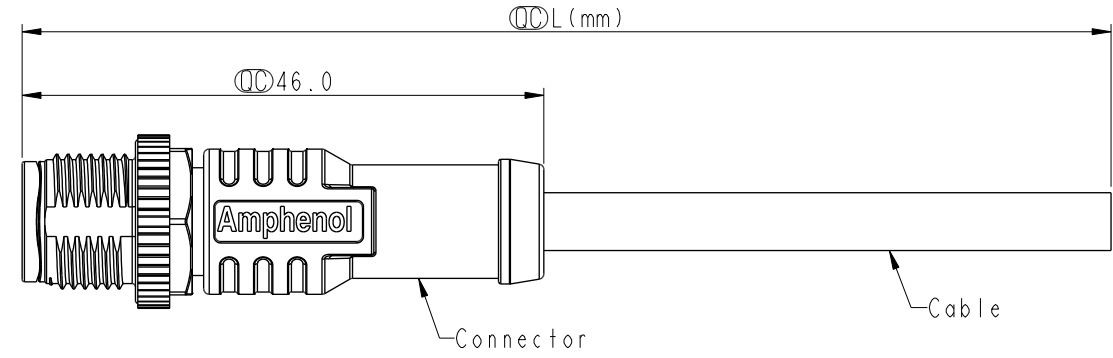

- Note: $\triangle D \triangle E \triangle F \triangle G$
- * RoHS Compliant
 - * ϕ Important dimension
 - $\triangle H$ * Waterproof rate: IP68, mated 1m/24h
IP69K, mated
 - * Connector
Housing: Thermoplastic, Black
Pin: Copper alloy, Gold plated
Nut: Metal
Outer mold: Thermoplastic, Black
 - * Cable: UL2517, PVC Jacket, Black
 - * Cable length tolerance: LM: +50/-0 mm
- | | |
|----------------|------------|
| 1M < L ≤ 3M: | +100/-0 mm |
| 3M < L ≤ 5M: | +150/-0 mm |
| 5M < L ≤ 10M: | ±100 mm |
| 10M < L ≤ 20M: | ±200 mm |
| 20M < L ≤ 30M: | ±300 mm |
| 30M < L ≤ 99M: | ±500 mm |

UNIT: mm		TITLE
TOLERANCE	$\pm 0.5mm$	N SEN, M12 B, SCREW CABLE W/O SR, M, M, MOLDING $\triangle G$
SCALE	3:2	SIZE
REV.	H	WC-REV.
		SHEET
		OF
		2
		QC: Inspection item

Amphenol LTW
安費諾亮泰企業股份有限公司

ITEM NO.	DRAWN BY	DATE
	Ruru	2019-01-21
DWG NO.	CHECKED BY	DATE
$\triangle E$ M12B-XXBMM-SL8DXX	Rita	2019-01-21
CUSTOMER	APPROVED BY	DATE
ALTW	Max	2019-01-21

THIS DOCUMENT IS SUBJECT TO CHANGE WITHOUT NOTICE. IT IS CONFIDENTIAL AND A PROPERTY OF Amphenol LTW. DISCLOSURE TO THIRD PARTY HAS TO BE AUTHORIZED BY Amphenol LTW.

	5P	5.1	22	MI2B-05BMMM-SL8DXX
	4P	4.8	22	MI2B-04BMMM-SL8DXX
Contacts	Cable OD	AWG	Item No.	

△B
△C
△G

△E

MI2B-XXBMMM-SL8DXX

XX: No. Of Pin

XX:01~99Meters
01:01Meter
02:02Meters
:
99:99Meters

△G

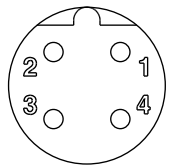
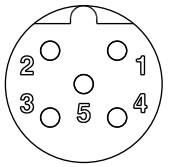
Pin Out	4	Black	黑	5	Gray	灰
	3	Blue	藍	4	Black	黑
	2	White	白	3	Blue	藍
	1	Brown	棕	2	White	白
				1	Brown	棕
	Pin #	Wire		Pin #	Wire	
Conn.						
	4P			5P		

Pin Assignments Front View

UNIT:mm	
TOLERANCE	±0.5mm

TITLE N SEN, MI2 B, SCREW CABLE W/O SR, M, M, MOLDING △E		
SCALE 3:2	SIZE A4	SHEET 2 OF 2
REV. H	WC-REV. A.2	QC: Inspection item

Amphenol LTW
安費諾亮泰企業股份有限公司

ITEM NO	DRAWN BY Ruru	DATE 2019-01-21
DWG NO △E MI2B-XXBMMM-SL8DXX	CHECKED BY Rita	DATE 2019-01-21
CUSTOMER ALTW	APPROVED BY Max	DATE 2019-01-21