

THIS DOCUMENT IS SUBJECT TO CHANGE WITHOUT NOTICE. IT IS CONFIDENTIAL AND A PROPERTY OF Amphenol LTW. DISCLOSURE TO THIRD PARTY HAS TO BE AUTHORIZED BY Amphenol LTW.

REV.	ECN NO.	DATE	SIGN	DESCRIPTION
C	C201578	2020/10/16	Ruru	X6
D	C210542	2021/04/07	Ruru	X3
E	C221874	2022/12/05	Ruru	X1

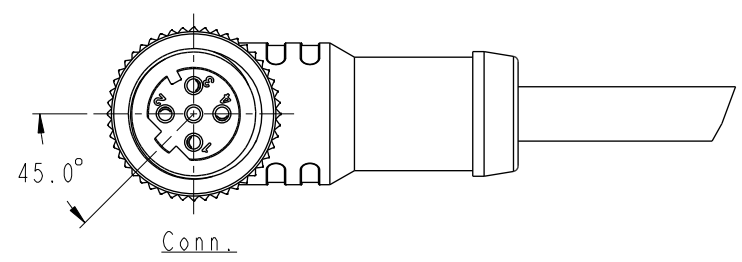
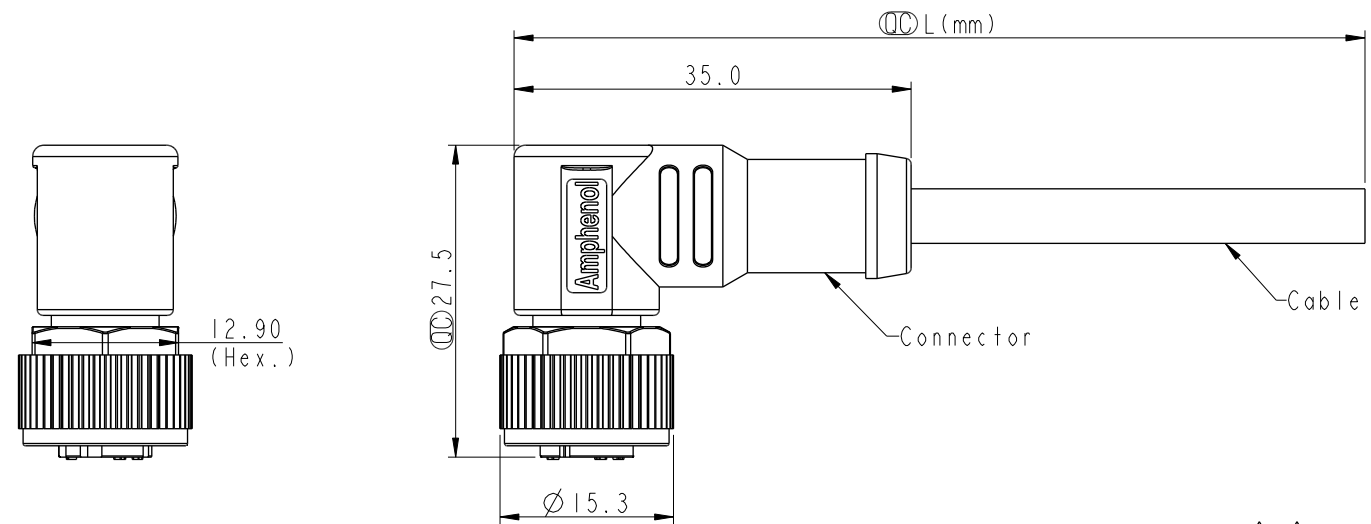

Note:   
 \* RoHS Compliant  
 \* Important dimension  
 \* Waterproof rate: IP68, mated 1m/24h  
 IP69K, mated

- \* Connector
- Housing: Thermoplastic, Black
- Pin: Copper alloy, Gold plated
- O-Ring: Rubber, Green
- Nut: Metal
- Outer mold: Thermoplastic, Black
- \* Cable: UL20549, PUR Jacket, Black
- \* Cable length tolerance: 1M: +50/-0 mm
- 1M < L ≤ 3M: +100/-0 mm
- 3M < L ≤ 5M: +150/-0 mm
- 5M < L ≤ 10M: ±100 mm
- 10M < L ≤ 20M: ±200 mm
- 20M < L ≤ 30M: ±300 mm
- 30M < L ≤ 99M: ±500 mm

UNIT: mm   
 TOLERANCE  
 ±0.5mm

TITLE N SEN, M12 D, SCREW CABLE W/O SR, F, F, MOLDING			
SCALE 3:2	SIZE A4	SHEET 1 OF 2	
REV. E	WC-REV. A.3	: Inspection item	

**Amphenol LTW**  
 安費諾亮泰企業股份有限公司

ITEM NO	DRAWN BY Yulong_wang	DATE 2016-10-14
DWG NO M12D-XXBFFM-SR8BXX	CHECKED BY Jinhai	DATE 2016-10-14
CUSTOMER ALTW	APPROVED BY Jerry	DATE 2016-10-14

THIS DOCUMENT IS SUBJECT TO CHANGE WITHOUT NOTICE. IT IS CONFIDENTIAL AND A PROPERTY OF Amphenol LTW. DISCLOSURE TO THIRD PARTY HAS TO BE AUTHORIZED BY Amphenol LTW.

	5P	4.4	22	M12D-05BFFM-SR8BXX
	4P	4.0		M12D-04BFFM-SR8BXX
	3P	3.8		M12D-03BFFM-SR8BXX
Contacts	Cable OD	AWG	Item No.	



  
 M12D-XXBFFM-SR8BXX  
 XX: No. Of Pin

XX: 01~99Meters  
 01: 01Meter  
 02: 02Meters  
 ...  
 99: 99Meters

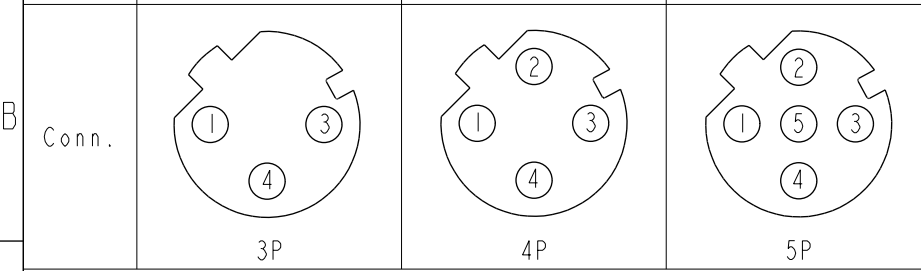
Pin Out	5	--		5	--		5	Gray	灰
	4	Black	黑	4	Black	黑	4	Black	黑
	3	Blue	藍	3	Blue	藍	3	Blue	藍
	2	--		2	White	白	2	White	白
	1	Brown	棕	1	Brown	棕	1	Brown	棕
	Pin #	Wire		Pin #	Wire		Pin #	Wire	



Pin Assignments Front View

UNIT:mm		TITLE N SEN, M12 D, SCREW CABLE W/O SR, F, F, MOLDING 	
TOLERANCE	±0.5mm	SCALE 3:2	SIZE A4
		REV. E	WC-REV. A.3
		SHEET 2 OF 2  : Inspection item	

Amphenol LTW

安費諾亮泰企業股份有限公司

ITEM NO	DRAWN BY	DATE
	Yulong_wang	2016-10-14
DWG NO	CHECKED BY	DATE
 M12D-XXBFFM-SR8BXX	Jinhai	2016-10-14
CUSTOMER	APPROVED BY	DATE
ALTW	Jerry	2016-10-14