

THIS DOCUMENT IS SUBJECT TO CHANGE WITHOUT NOTICE. IT IS CONFIDENTIAL AND A PROPERTY OF Amphenol LTW. DISCLOSURE TO THIRD PARTY HAS TO BE AUTHORIZED BY Amphenol LTW.

REV.	ECN NO.	DATE	SIGN	DESCRIPTION
E	C201451	2020/10/12	Ruru	△E X5
F	C210222	2021/03/19	Vicky	△F X4
G	C230008	2023/01/04	Vicky	△G X1

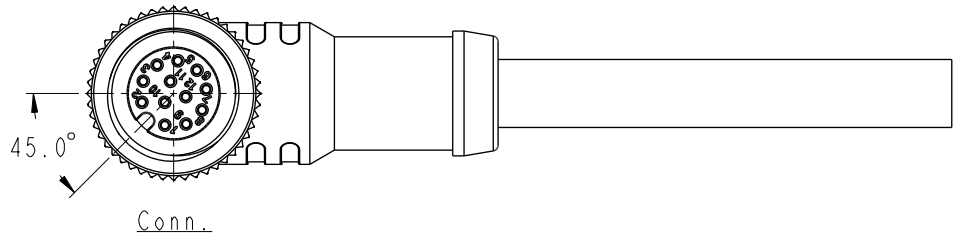

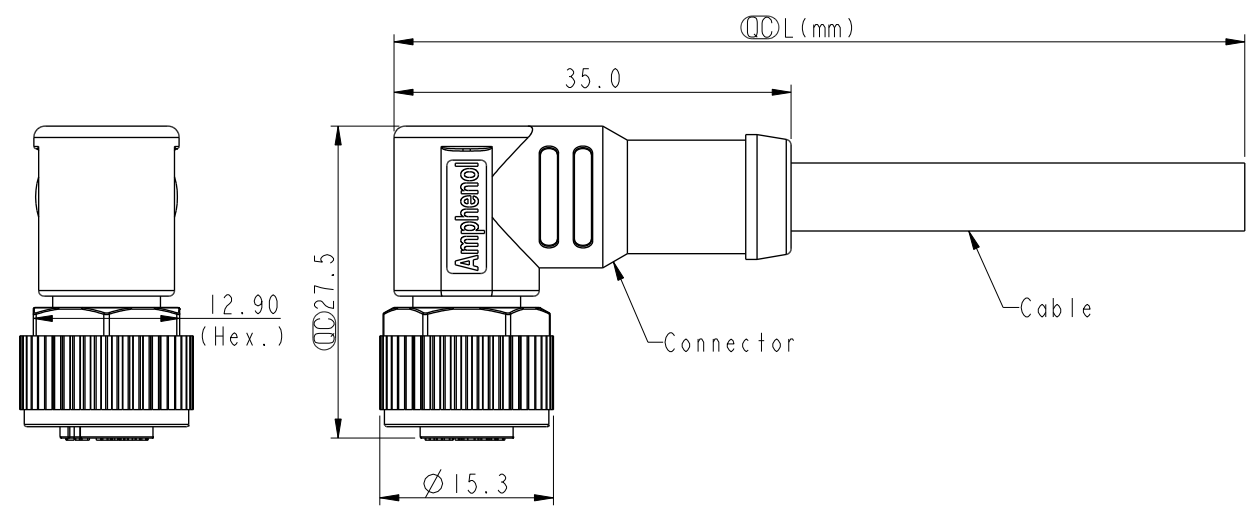

- △E △F
 Note:
 * RoHS Compliant
 * ∅ Important dimension
 △C △G * Waterproof rate: IP68, mated 1m/24h
 IP69K, mated
 * Connector
 Housing: Thermoplastic, Black
 Pin: Copper alloy, Gold plated
 O-Ring: Rubber, Green
 △B Nut: Thermoplastic, Black
 Outer mold: Thermoplastic, Black
 * Cable: UL2517, PVC Jacket, Yellow
 * Cable length tolerance: 1M: +50/-0 mm
 1M < L ≤ 3M: +100/-0 mm
 3M < L ≤ 5M: +150/-0 mm
 5M < L ≤ 10M: ±100 mm
 10M < L ≤ 20M: ±200 mm
 20M < L ≤ 30M: ±300 mm
 30M < L ≤ 99M: ±500 mm

UNIT: mm
 TOLERANCE
 ±0.5mm

TITLE N SEN, M12 A -PLASTIC, SCREW CABLE W/O SR, F, F, MOLDING			△E
SCALE 3:2	SIZE A4	SHEET 1 OF 2	
REV. G	WC-REV. A.3	∅ Inspection item	

Amphenol LTW
 安費諾亮泰企業股份有限公司

ITEM NO	DRAWN BY Lingpeng	DATE 2017-04-06
DWG NO △E MSAP-XXBFFM-SR8AXX	CHECKED BY Ma Fei	DATE 2017-04-06
CUSTOMER ALTW	APPROVED BY Jerry	DATE 2017-04-06

 MSAP-XXBFFM-SR8AXX									
XX: No. Of Pin	XX: 01~99Meters 01: 01Meter 02: 02Meters : 99: 99Meters								
									
						12P	6.0	26	MSAP-12BFFM-SR8AXX
						10P			MSAP-10BFFM-SR8AXX
						8P	5.5	24	MSAP-08BFFM-SR8AXX
						6P	5.0		MSAP-06BFFM-SR8AXX
						5P	5.1		MSAP-05BFFM-SR8AXX
						4P	4.8	22	MSAP-04BFFM-SR8AXX
						3P	4.5		MSAP-03BFFM-SR8AXX
						Contacts	Cable OD	AWG	Item No.

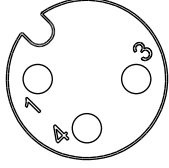
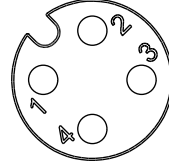
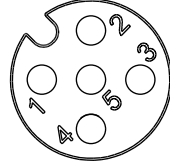
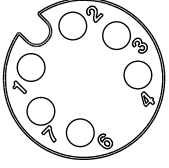
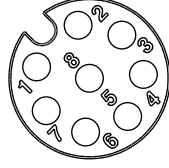
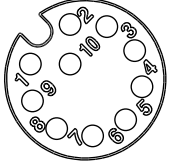
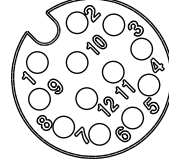
Pin Out																	
5	--	5	--	5	Gray	灰	8	--	8	Red	紅	12	--	12	Red/Blue	紅/藍	
4	Black	黑	4	Black	黑	4	Black	黑	7	Blue	藍	7	Blue	藍	11	Gray/Pink	灰/粉
3	Blue	藍	3	Blue	藍	3	Blue	藍	6	Pink	粉	6	Pink	粉	10	Violet	紫
2	--	棕	2	White	白	2	White	白	5	Gray	灰	5	Gray	灰	9	Black	黑
1	Brown	棕	1	Brown	棕	1	Brown	棕	4	Yellow	黃	4	Yellow	黃	8	Red	紅
1	Brown	棕	1	Brown	棕	1	White	白	3	Green	綠	3	Green	綠	7	Blue	藍
1	Brown	棕	1	Brown	棕	1	White	白	2	Brown	棕	2	Brown	棕	6	Pink	粉
1	White	白	1	White	白	1	White	白	1	White	白	1	White	白	3	Green	綠
1	White	白	1	White	白	1	White	白	1	White	白	1	White	白	2	Brown	棕
1	White	白	1	White	白	1	White	白	1	White	白	1	White	白	1	White	白
Pin #	Wire		Pin #	Wire		Pin #	Wire		Pin #	Wire		Pin #	Wire		Pin #	Wire	
Conn.	      																
3P																	
4P																	
5P																	
△ 6P																	
8P																	
10P																	
12P																	

Pin Assignments Front View

UNIT:mm		TITLE N SEN, M12 A -PLASTIC, SCREW CABLE W/O SR, F, F, MOLDING			Amphenol LTW 安費諾亮泰企業股份有限公司	ITEM NO	DRAWN BY	DATE								
TOLERANCE	±0.5mm	SCALE	3:2	SIZE	A4	SHEET	2	OF	2	DWG NO	MSAP-XXBFFM-SR8AXX		CHECKED BY	Ma Fei	DATE	2017-04-06
REV.	G	WC-REV.	A.3	 Inspection item		CUSTOMER	ALTW		APPROVED BY	Jerry	DATE	2017-04-06				