

THIS DOCUMENT IS SUBJECT TO CHANGE WITHOUT NOTICE. IT IS CONFIDENTIAL AND A PROPERTY OF Amphenol LTW. DISCLOSURE TO THIRD PARTY HAS TO BE AUTHORIZED BY Amphenol LTW.

REV.	ECN NO.	DATE	SIGN	DESCRIPTION
E	C201451	2020/10/12	Ruru	△E X5
F	C210222	2021/03/19	Vicky	△F X4
G	C230008	2023/01/04	Vicky	△G XI

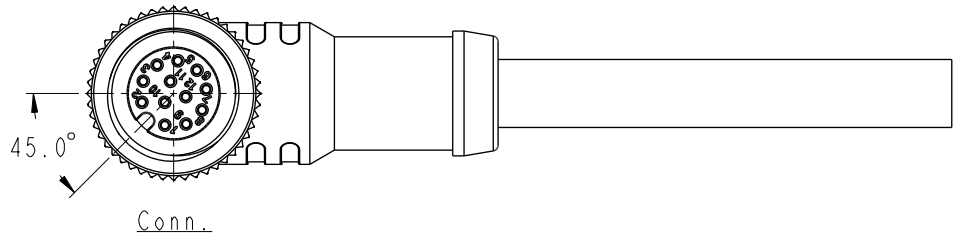

- △E △F  
 Note:  
 \* RoHS Compliant  
 \* ∅ Important dimension  
 △C △G \* Waterproof rate: IP68, mated 1m/24h  
 IP69K, mated  
 \* Connector  
 Housing: Thermoplastic, Black  
 Pin: Copper alloy, Gold plated  
 O-Ring: Rubber, Green  
 △B Nut: Thermoplastic, Black  
 Outer mold: Thermoplastic, Black  
 △B \* Cable: UL2517, PVC Jacket, Black  
 \* Cable length tolerance: 1M: +50/-0 mm  
 1M < L ≤ 3M: +100/-0 mm  
 3M < L ≤ 5M: +150/-0 mm  
 5M < L ≤ 10M: ±100 mm  
 10M < L ≤ 20M: ±200 mm  
 20M < L ≤ 30M: ±300 mm  
 30M < L ≤ 99M: ±500 mm

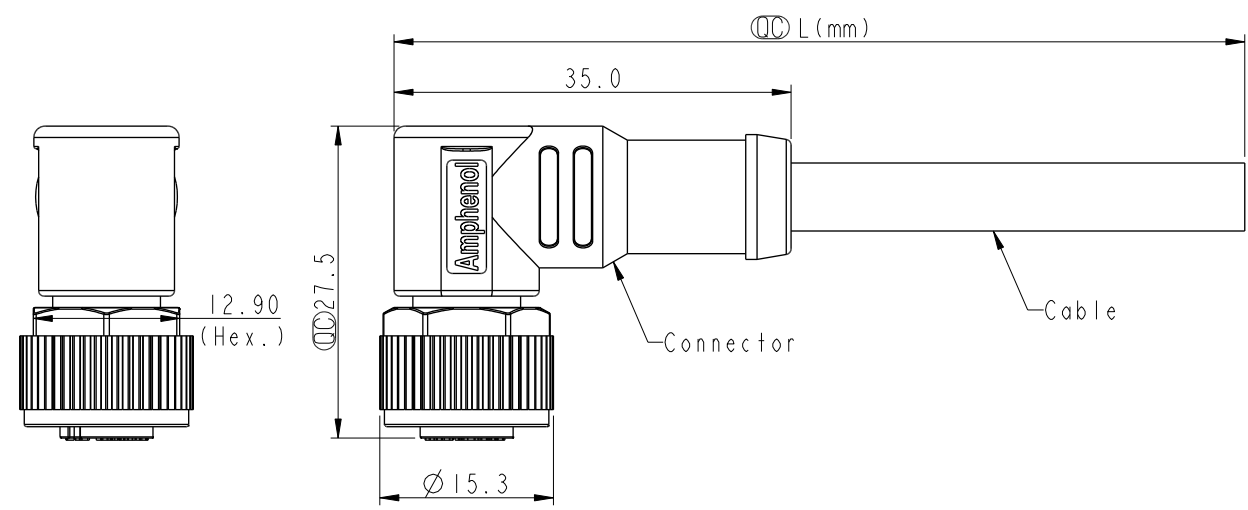

UNIT: mm  
 TOLERANCE  
 ±0.5mm



TITLE N SEN, M12 A -PLASTIC, SCREW CABLE W/O SR, F, F, MOLDING		
SCALE 3:2	SIZE A4	SHEET 1 OF 2
REV. G	WC-REV. A.3	∅ Inspection item

**Amphenol LTW**  
 安費諾亮泰企業股份有限公司

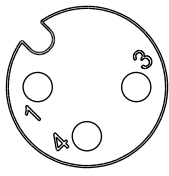
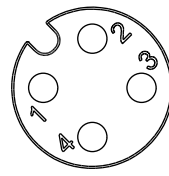
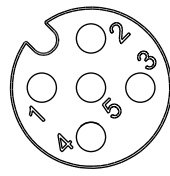
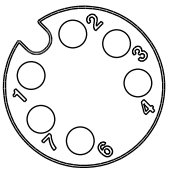
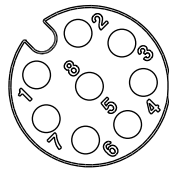
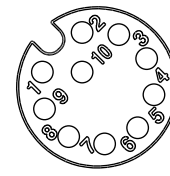
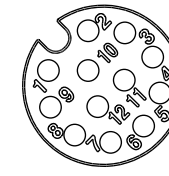

ITEM NO	DRAWN BY Lingpeng	DATE 2017-04-06
DWG NO △E MSAP-XXBFFM-SR8DXX	CHECKED BY Ma Fei	DATE 2017-04-06
CUSTOMER ALTW	APPROVED BY Jerry	DATE 2017-04-06

THIS DOCUMENT IS SUBJECT TO CHANGE WITHOUT NOTICE. IT IS CONFIDENTIAL AND A PROPERTY OF Amphenol LTW. DISCLOSURE TO THIRD PARTY HAS TO BE AUTHORIZED BY Amphenol LTW.

 <b>MSAP-XXBFFM-SR8DXX</b> XX: No. Of Pin	XX: 01~99Meters 01: 01Meter 02: 02Meters : 99: 99Meters								
 12P 10P 8P 6P 5P 4P 3P Contacts	6.0 5.5 5.0 5.1 4.8 4.5 Cable OD	26 24 22 AWG	MSAP-12BFFM-SR8DXX MSAP-10BFFM-SR8DXX MSAP-08BFFM-SR8DXX MSAP-06BFFM-SR8DXX MSAP-05BFFM-SR8DXX MSAP-04BFFM-SR8DXX MSAP-03BFFM-SR8DXX Item No.						

Pin Out	5 -- 4 Black 黑 3 Blue 藍 2 -- 1 Brown 棕	5 -- 4 Black 黑 3 Blue 藍 2 White 白 1 Brown 棕	5 Gray 灰 4 Black 黑 3 Blue 藍 2 White 白 1 Brown 棕	8 -- 7 Blue 藍 6 Pink 粉 5 -- 4 Yellow 黃 3 Green 綠 2 Brown 棕 1 White 白	8 Red 紅 7 Blue 藍 6 Pink 粉 5 Gray 灰 4 Yellow 黃 3 Green 綠 2 Brown 棕 1 White 白	12 -- 11 -- 10 Violet 紫 9 Black 黑 8 Red 紅 7 Blue 藍 6 Pink 粉 5 Gray 灰 4 Yellow 黃 3 Green 綠 2 Brown 棕 1 White 白	12 Red/Blue 紅/藍 11 Gray/Pink 灰/粉 10 Violet 紫 9 Black 黑 8 Red 紅 7 Blue 藍 6 Pink 粉 5 Gray 灰 4 Yellow 黃 3 Green 綠 2 Brown 棕 1 White 白	12 Red/Blue 紅/藍 11 Gray/Pink 灰/粉 10 Violet 紫 9 Black 黑 8 Red 紅 7 Blue 藍 6 Pink 粉 5 Gray 灰 4 Yellow 黃 3 Green 綠 2 Brown 棕 1 White 白	
	Pin # Wire	Pin # Wire	Pin # Wire	Pin # Wire	Pin # Wire	Pin # Wire	Pin # Wire	Pin # Wire	Pin # Wire
Conn.									
	3P	4P	5P	 6P	8P	10P	12P		

Pin Assignments Front View

UNIT:mm		TITLE N SEN, M12 A -PLASTIC, SCREW CABLE W/O SR, F, F, MOLDING		ITEM NO	DRAWN BY Lingpeng	DATE 2017-04-06
TOLERANCE ±0.5mm	SCALE 3:2	SIZE A4	SHEET 2 OF 2	DWG NO  MSAP-XXBFFM-SR8DXX	CHECKED BY Ma Fei	DATE 2017-04-06
	REV. G	WC-REV. A.3	 Inspection item	CUSTOMER ALTW	APPROVED BY Jerry	DATE 2017-04-06

# Amphenol LTW

## 安費諾亮泰企業股份有限公司