

THIS DOCUMENT IS SUBJECT TO CHANGE WITHOUT NOTICE. IT IS CONFIDENTIAL AND A PROPERTY OF Amphenol LTW. DISCLOSURE TO THIRD PARTY HAS TO BE AUTHORIZED BY Amphenol LTW.

REV.	ECN NO.	DATE	SIGN	DESCRIPTION
B	C201759 & 60	2020/11/17	Vicky	△B X4
C	C210232	2021/04/06	Vicky	△C X4
D	C230019	2023/01/06	Vicky	△D X2

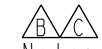
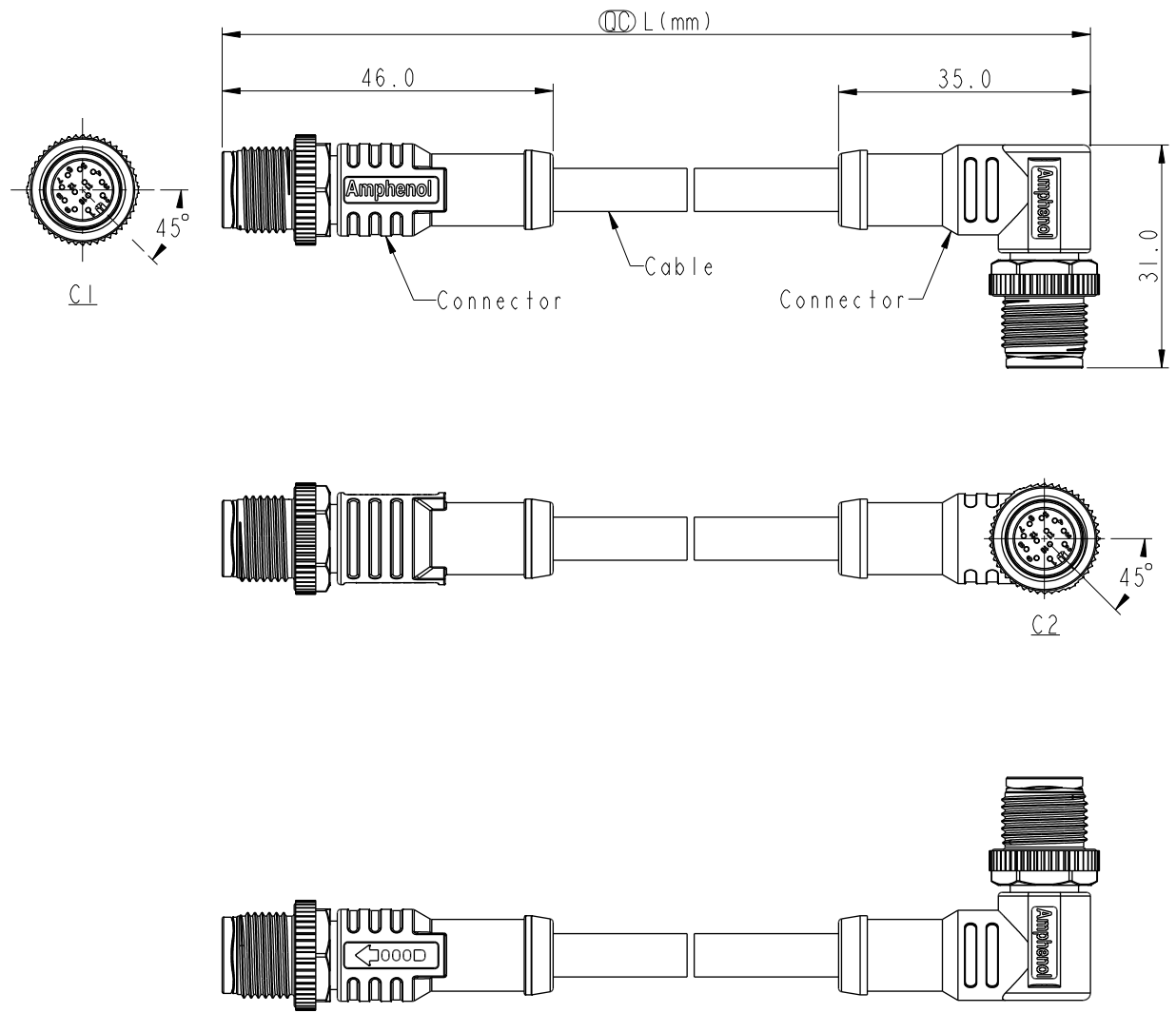

Note:

- \* RoHS Compliant
- \*  $\text{Ⓞ}$  Important dimension
- \* C1

△D Waterproof rate: IP68, mated 1m/24h  
IP69K, mated

- Housing: Thermoplastic, Black
- Pin: Copper alloy, Gold plated
- Nut: Thermoplastic, Black
- Outer Mold: Thermoplastic, Black

\* C2

△D Waterproof rate: IP68, mated 1m/24h  
IP69K, mated

- Housing: Thermoplastic, Black
- Pin: Copper alloy, Gold plated
- Nut: Thermoplastic, Black
- Outer Mold: Thermoplastic, Black



- \* Cable: UL20549, PUR Jacket, Black
- \* Cable Length Tolerance:
 

0.5M < L ≤ 1M:	+60/-0 mm
1M < L ≤ 3M:	+120/-0 mm
3M < L ≤ 5M:	+160/-0 mm
5M < L ≤ 10M:	±100 mm
10M < L ≤ 20M:	±200 mm
20M < L ≤ 30M:	±300 mm
30M < L ≤ 99M:	±500 mm

UNIT: mm		TITLE	ACC, SEN, A Code, DB-ENDED	△C					
TOLERANCE	±0.5mm	SCALE	1:2	SIZE	A4	SHEET	1	OF	2
		REV.	D	WC-REV.		$\text{Ⓞ}$	Inspection item		



**Amphenol LTW**  
安費諾亮泰企業股份有限公司

ITEM NO.	DRAWN BY	DATE
	Vicky	2018-12-07
DWG NO.	CHECKED BY	DATE
△B MSAPXXML-SAPMR-SBXXX	Rita	2018-12-07
CUSTOMER	APPROVED BY	DATE
ALTW	Max	2018-12-07

F	 MSAPXXML-SAPMR-SBXXX XX: No. Of Pin	XXX: 0.5~99Meters A05: 0.5 Meter 1: 01 Meter 2: 02 Meters : 99: 99 Meters	12P	6.0	26	MSAP12ML-SAPMR-SBXXX
			10P			MSAP10ML-SAPMR-SBXXX
E			8P	4.8	24	MSAP08ML-SAPMR-SBXXX
			6P	5.0		MSAP06ML-SAPMR-SBXXX
			5P	4.4	22	MSAP05ML-SAPMR-SBXXX
			4P	4.0		MSAP04ML-SAPMR-SBXXX
			3P	3.8		MSAP03ML-SAPMR-SBXXX
			 Contacts	Cable OD	AWG	Item No.

D	Pin Out	5 --	5 --	5 Gray	8 --	8 Red	12 --	12 Red/Blue
		4 Black	4 Black	4 Black	7 Blue	7 Blue	11 --	11 Gray/Pink
C		3 Blue	3 Blue	3 Blue	6 Pink	6 Pink	10 Violet	10 Violet
		2 --	2 White	2 White	5 --	5 Gray	9 Black	9 Black
B		1 Brown	1 Brown	1 Brown	4 Yellow	4 Yellow	8 Red	8 Red
					3 Green	3 Green	7 Blue	7 Blue
					2 Brown	2 Brown	6 Pink	6 Pink
					1 White	1 White	5 Gray	5 Gray
							4 Yellow	4 Yellow
							3 Green	3 Green
							2 Brown	2 Brown
							1 White	1 White

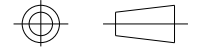
Pin Assignments Front View

A	UNIT:mm		TITLE	ACC, SEN, A Code, DB-ENDED 		ITEM NO	DRAWN BY	DATE
	TOLERANCE	±0.5mm	SCALE	1:2	SIZE	A4	CHECKED BY	Rita
			REV.	D	WC-REV.		APPROVED BY	Max
			SHEET	2	OF	2	CUSTOMER	ALTW
			<b>Amphenol LTW</b>					
			安費諾亮泰企業股份有限公司					
			 Inspection item			DATE 2018-12-07		