

THIS DOCUMENT IS SUBJECT TO CHANGE WITHOUT NOTICE. IT IS CONFIDENTIAL AND A PROPERTY OF Amphenol LTW. DISCLOSURE TO THIRD PARTY HAS TO BE AUTHORIZED BY Amphenol LTW.

REV.	ECN NO.	DATE	SIGN	DESCRIPTION
C	C201595	2020/10/16	Ruru	$\triangle C$ X6
D	C210211	2021/03/22	Ruru	$\triangle D$ X3
E	C221876	2022/12/06	Ruru	$\triangle E$ X1

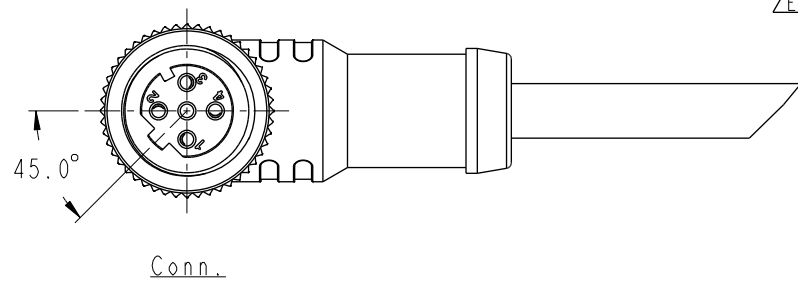

- Note: $\triangle C$ $\triangle D$
- * RoHS Compliant
 - * \circ Important dimension
 - $\triangle E$ $\triangle B$ * Waterproof rate: IP68, mated 1m/24h
IP69K, mated
 - * Connector
 - Housing: Thermoplastic, Black
 - Pin: Copper alloy, Gold plated
 - O-Ring: Rubber, Green
 - Nut: Thermoplastic, Black
 - Outer mold: Thermoplastic, Black
 - $\triangle B$ * Cable: UL20549, PUR Jacket, Black
 - * Cable length tolerance: 1M: +50/-0 mm
 1M < L ≤ 3M: +100/-0 mm
 3M < L ≤ 5M: +150/-0 mm
 5M < L ≤ 10M: ±100 mm
 10M < L ≤ 20M: ±200 mm
 20M < L ≤ 30M: ±300 mm
 30M < L ≤ 99M: ±500 mm

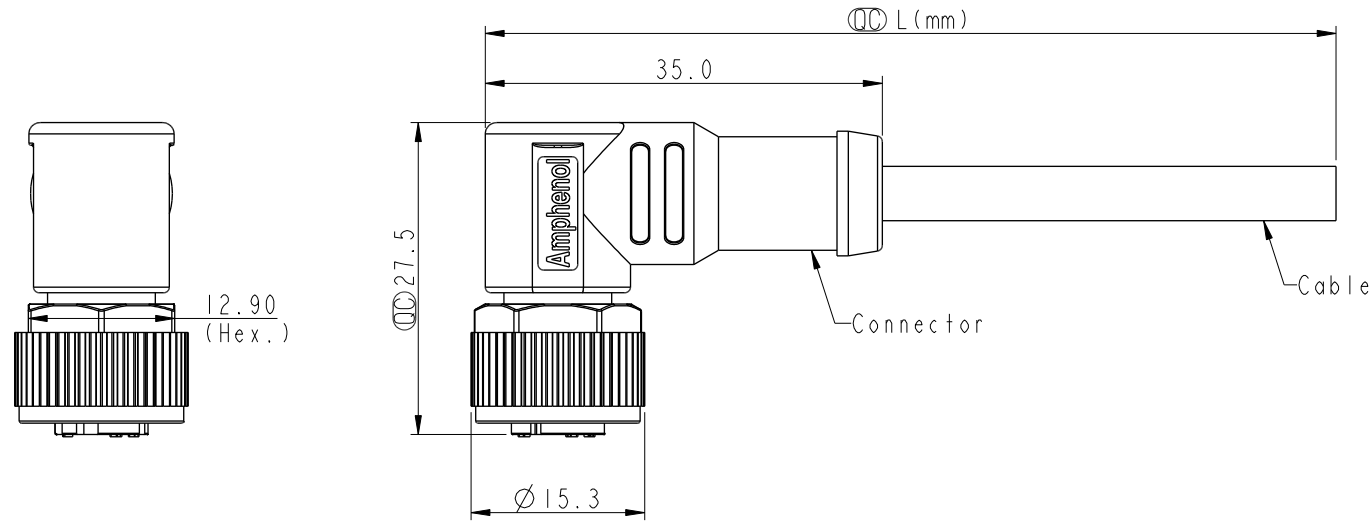

UNIT: mm
 TOLERANCE
 ±0.5mm



TITLE N SEN, M12 D -PLASTIC, SCREW CABLE W/O SR, F, F, MOLDING $\triangle D$			
SCALE 3:2	SIZE A4	SHEET 1 OF 2	
REV. E	WC-REV. A.2	\circ : Inspection item	

Amphenol LTW
 安費諾亮泰企業股份有限公司

ITEM NO.	DRAWN BY Yulong_wang	DATE 2016-10-14
DWG NO. $\triangle C$ MSDP-XXBFFM-SR8BXX	CHECKED BY Jinhai	DATE 2016-10-14
CUSTOMER ALTW	APPROVED BY Jerry	DATE 2016-10-14

THIS DOCUMENT IS SUBJECT TO CHANGE WITHOUT NOTICE. IT IS CONFIDENTIAL AND A PROPERTY OF Amphenol LTW. DISCLOSURE TO THIRD PARTY HAS TO BE AUTHORIZED BY Amphenol LTW.

 	5P	4.4	22	MSDP-05BFFM-SR8BXX
	4P	4.0		MSDP-04BFFM-SR8BXX
	3P	3.8		MSDP-03BFFM-SR8BXX
Contacts	Cable OD	AWG	Item No.	





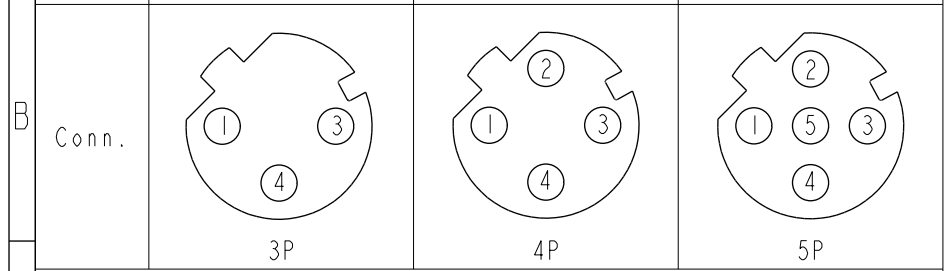

 MSDP-XXBFFM-SR8BXX
 XX: No. Of Pin

XX: 01~99Meters
 01: 01Meter
 02: 02Meters
 :
 99: 99Meters

Pin Out	5	--		5	--		5	Gray	灰
	4	Black	黑	4	Black	黑	4	Black	黑
	3	Blue	藍	3	Blue	藍	3	Blue	藍
	2	--		2	White	白	2	White	白
	1	Brown	棕	1	Brown	棕	1	Brown	棕
	Pin #	Wire		Pin #	Wire		Pin #	Wire	



Pin Assignments Front View

UNIT:mm			TITLE N SEN, M12 D -PLASTIC, SCREW CABLE W/O SR, F, F, MOLDING 
TOLERANCE	±0.5mm		
SCALE	3:2	SIZE	A4
REV.	E	WC-REV.	A.2
		SHEET	2 OF 2
		 : Inspection item	

Amphenol LTW

安費諾亮泰企業股份有限公司

ITEM NO	DRAWN BY	DATE
	Yulong_wang	2016-10-14
DWG NO	CHECKED BY	DATE
 MSDP-XXBFFM-SR8BXX	Jinhai	2016-10-14
CUSTOMER	APPROVED BY	DATE
ALTW	Jerry	2016-10-14