

THIS DOCUMENT IS SUBJECT TO CHANGE WITHOUT NOTICE. IT IS CONFIDENTIAL AND A PROPERTY OF AMPHENOL LTW. DISCLOSURE TO THIRD PARTY HAS TO BE AUTHORIZED BY AMPHENOL LTW.

| REV. | ECN NO. | DATE | SIGN | DESCRIPTION |
|------|---------|------------|------------|------------------|
| C | C200652 | 2020/05/15 | Wesley Lin | $\triangle C$ XI |
| D | C220466 | 2022/04/12 | Ruru | $\triangle D$ X8 |
| E | C230121 | 2023/02/06 | Ruru | $\triangle E$ XI |

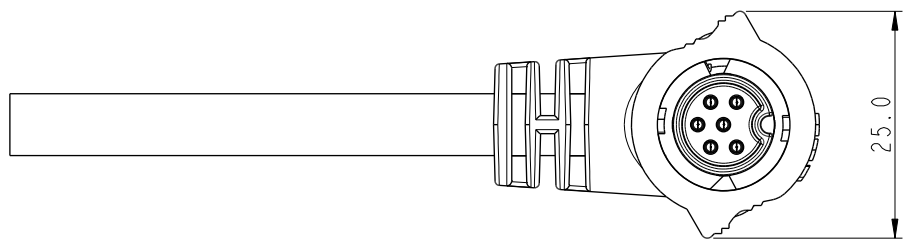
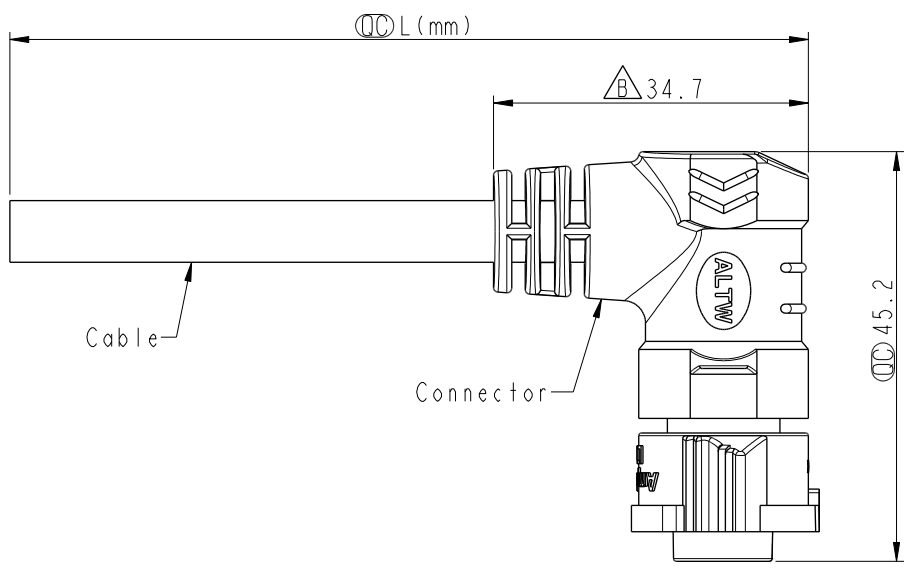

- Note: $\triangle D$
- * RoHS Compliant
 - * \circ Important dimension
 - $\triangle E$ * Waterproof rate: IP68, mated 1m/24h
 - * Connector
 - Housing: Thermoplastic, Black
 - Pin: Copper Alloy, Gold Plated
 - O-Ring: Rubber, Dark Gray
 - Nut: Thermoplastic, Black
 - Outer mold: Thermoplastic, Black
 - * Cable: UL21388, PVC Jacket, Black
 - * Cable length tolerance: IM: +50/-0 mm
- | | |
|---------------|------------|
| 1M < L ≤ 3M | +100/-0 mm |
| 3M < L ≤ 5M | +150/-0 mm |
| 5M < L ≤ 10M | ±100 mm |
| 10M < L ≤ 20M | ±200 mm |
| 20M < L ≤ 30M | ±300 mm |
| 30M < L ≤ 99M | ±500 mm |

| | | |
|-----------|--|--|
| UNIT: mm | | |
| TOLERANCE | | |
| ±0.5 mm | | |

| | | | |
|---|---------------|---------------------------|--|
| TITLE XLOK, B-5A, CABLE W/SR F, M, MOLDING, PUSH LOCK $\triangle D$ | | | |
| SCALE 6:5 | SIZE A4 | SHEET 1 OF 2 | |
| REV. E | WC-REV. .0 | \circ : Inspection item | |

Amphenol LTW
安費諾亮泰企業股份有限公司

| | | |
|---|--------------------------|--------------------|
| ITEM NO. | DRAWN BY Frank Deng | DATE 2017-02-15 |
| DWG NO. BD-XXAFMM-OR8DXX $\triangle D$ | CHECKED BY Spring Liu | DATE 2017-02-15 |
| CUSTOMER ALTW | APPROVED BY Kevin Hu | DATE 2017-02-15 |



THIS DOCUMENT IS SUBJECT TO CHANGE WITHOUT NOTICE. IT IS CONFIDENTIAL AND A PROPERTY OF Amphenol LTW. DISCLOSURE TO THIRD PARTY HAS TO BE AUTHORIZED BY Amphenol LTW.

| | | |
|----------|----------|----------|
| 6 | 7 | 8 |
| 6P | 6.8 | 20 |
| 5P | 6.2 | |
| 4P | 6.0 | |
| 3P | 5.5 | |
| 2P | 5.5 | |
| Contacts | Cable OD | AWG |
| | | Item No. |

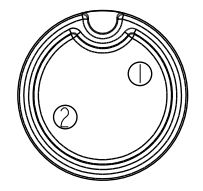
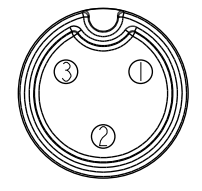
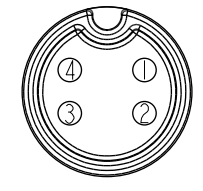
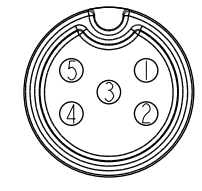
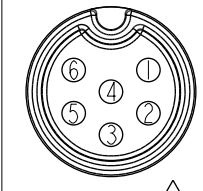

 BD-XXAFMM-QR8DXX

XX: No. Of Pin

XX: 01~99Meters
 01: 01Meter
 02: 02Meters
 :
 99: 99Meters

| | | | | | |
|---------|---|---|---|--|--|
| Pin Out | 2 Brown 棕 1 Black 黑 | 3 Red 紅 2 Brown 棕 1 Black 黑 | 4 Orange 橙 3 Red 紅 2 Brown 棕 1 Black 黑 | 5 Yellow 黃 4 Orange 橙 3 Red 紅 2 Brown 棕 1 Black 黑 | 6 Green 綠 5 Yellow 黃 4 Orange 橙 3 Red 紅 2 Brown 棕 1 Black 黑 |
| | Pin # Wire | Pin # Wire | Pin # Wire | Pin # Wire | Pin # Wire |
| Conn. |  |  |  |  |  |
| | 2P | 3P | 4P | 5P | 6P  |

Pin Assignments Front View

| | | |
|-----------|---|--|
| UNIT:mm |  | TITLE |
| TOLERANCE | ±0.5 mm | XLOK, B-5A, CABLE W/SR F, M, MOLDING, PUSH LOCK  |
| SCALE | 6:5 | SIZE A4 |
| REV. | E | SHEET 2 OF 2 |
| | WC-REV. .0 | QC: Inspection item |

Amphenol LTW
 安費諾亮泰企業股份有限公司

| | | |
|----------|--------------------------------------|--|
| ITEM NO | DRAWN BY | DATE |
| DWG NO | CHECKED BY | DATE |
| CUSTOMER | APPROVED BY | DATE |
| ALTW | Frank Deng Spring Liu Kevin Hu | 2017-02-15 2017-02-15 2017-02-15 |