

THIS DOCUMENT IS SUBJECT TO CHANGE WITHOUT NOTICE. IT IS CONFIDENTIAL AND A PROPERTY OF Amphenol LTW. DISCLOSURE TO THIRD PARTY HAS TO BE AUTHORIZED BY Amphenol LTW.

REV.	ECN NO.	DATE	SIGN	DESCRIPTION
A		2022/07/11	San	New Item
B	C221951	2022/12/16	Ruru	$\triangle B$ XI

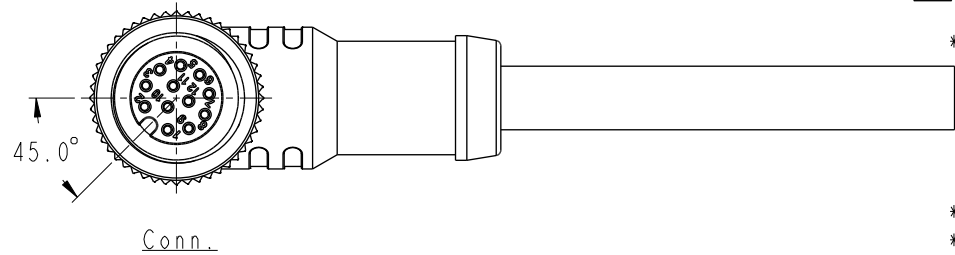
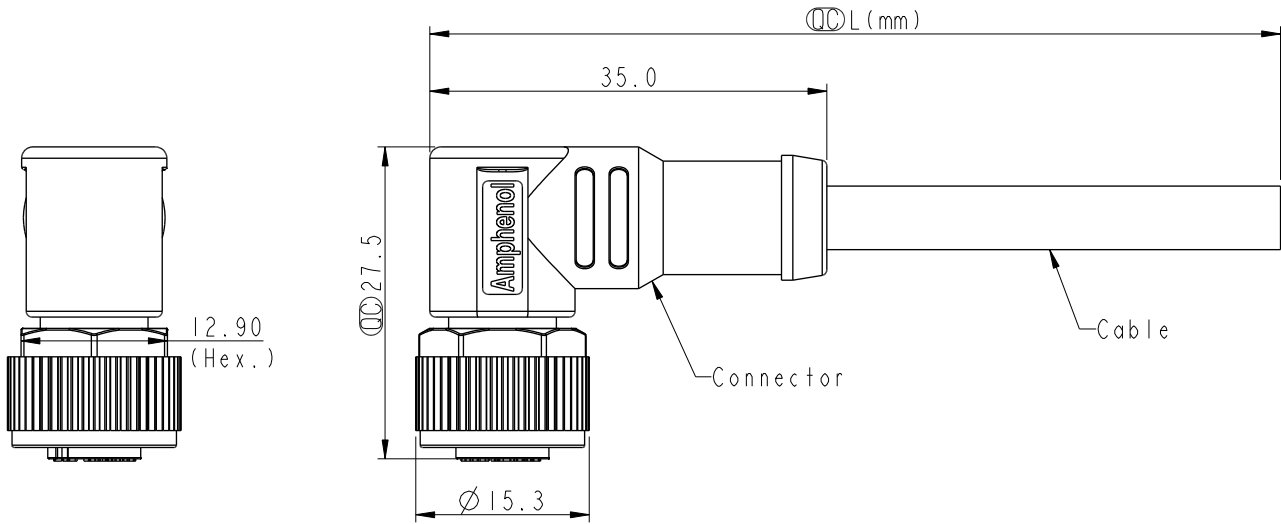

Note:  
 \* RoHS Compliant  
 \*  $\varnothing$  Important dimension  
 $\triangle B$  \* Waterproof rate: IP68, mated 1m/24h  
 IP69K, mated

- \* Connector  
 Housing: Thermoplastic, Black  
 Pin: Copper alloy, Gold plated  
 O-Ring: Rubber, Green  
 Nut: Metal  
 Outer mold: Thermoplastic, Black
- \* Cable: UL20549, TPU Jacket, Black
- \* Cable length tolerance: 1M: +50/-0 mm  
 1M < L ≤ 3M: +100/-0 mm  
 3M < L ≤ 5M: +150/-0 mm  
 5M < L ≤ 10M: ±100 mm  
 10M < L ≤ 20M: ±200 mm  
 20M < L ≤ 30M: ±300 mm  
 30M < L ≤ 99M: ±500 mm

UNIT: mm		TITLE N SEN, M12 A, SCREW CABLE W/O SR, F, F, MOLDING
TOLERANCE ±0.5mm	SCALE 3:2	SIZE A4
	REV. B	SHEET 1 OF 2
	WC-REV. .0	$\varnothing$ Inspection item

**Amphenol LTW**  
 安費諾亮泰企業股份有限公司

ITEM NO	DRAWN BY San	DATE 2022-07-11
DWG NO M12A-XXBFFM-SR8NXX	CHECKED BY Feng	DATE 2022-07-11
CUSTOMER ALTW	APPROVED BY Jerry	DATE 2022-07-11

THIS DOCUMENT IS SUBJECT TO CHANGE WITHOUT NOTICE. IT IS CONFIDENTIAL AND A PROPERTY OF Amphenol LTW. DISCLOSURE TO THIRD PARTY HAS TO BE AUTHORIZED BY Amphenol LTW.

F	<p>M12A-XXBFFM-SR8NXX</p> <p>XX: No. Of Pin</p> <p style="margin-left: 200px;">XX: 01~99Meters 01: 01Meter 02: 02Meters : 99: 99Meters</p>						26	24	22	20
							12P	6.2		M12A-12BFFM-SR8NXX
							10P	6.0		M12A-10BFFM-SR8NXX
							8P	6.7		M12A-08BFFM-SR8NXX
							6P	5.5		M12A-06BFFM-SR8NXX
							5P	5.6		M12A-05BFFM-SR8NXX
							4P	5.4		M12A-04BFFM-SR8NXX
							3P	5.2		M12A-03BFFM-SR8NXX
E							Contacts	Cable OD	AWG	Item No.

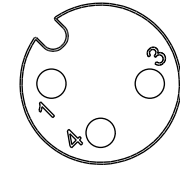
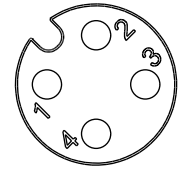
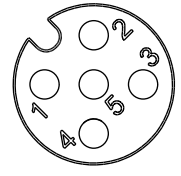
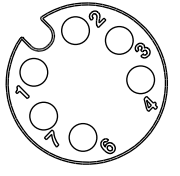
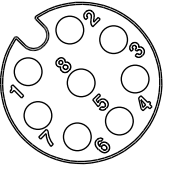
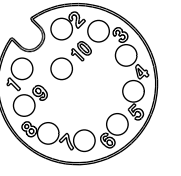
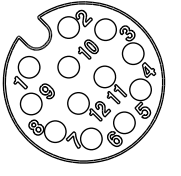
C	Pin Out										
	5 -- 4 White 白 3 Blue 藍 2 -- 1 Brown 棕	5 -- 4 Orange 橘 3 Red 紅 2 Brown 棕 1 Black 黑	5 Yellow 黃 4 Orange 橘 3 Red 紅 2 Brown 棕 1 Black 黑	8 -- 7 Gray 灰 6 Yellow 黃 5 -- 4 Green 綠 3 White 白 2 Blue 藍 1 Brown 棕	8 Violet 紫 7 Blue 藍 6 Green 綠 5 Yellow 黃 4 Orange 橘 3 Red 紅 2 Brown 棕 1 Black 黑	8 -- 7 Gray 灰 6 Yellow 黃 5 -- 4 Green 綠 3 White 白 2 Blue 藍 1 Brown 棕	8 Violet 紫 7 Blue 藍 6 Green 綠 5 Yellow 黃 4 Orange 橘 3 Red 紅 2 Brown 棕 1 Black 黑	12 -- 11 -- 10 Violet 紫 9 Black 黑 8 Red 紅 7 Pink 粉 6 Gray 灰 5 Yellow 黃 4 Green 綠 3 White 白 2 Blue 藍 1 Brown 棕	12 Red/Blue 紅/藍 11 Gray/Pink 灰/粉 10 Violet 紫 9 Black 黑 8 Red 紅 7 Pink 粉 6 Gray 灰 5 Yellow 黃 4 Green 綠 3 White 白 2 Blue 藍 1 Brown 棕	12 Red/Blue 紅/藍 11 Gray/Pink 灰/粉 10 Violet 紫 9 Black 黑 8 Red 紅 7 Pink 粉 6 Gray 灰 5 Yellow 黃 4 Green 綠 3 White 白 2 Blue 藍 1 Brown 棕	12 Red/Blue 紅/藍 11 Gray/Pink 灰/粉 10 Violet 紫 9 Black 黑 8 Red 紅 7 Pink 粉 6 Gray 灰 5 Yellow 黃 4 Green 綠 3 White 白 2 Blue 藍 1 Brown 棕
	Pin # Wire	Pin # Wire	Pin # Wire	Pin # Wire	Pin # Wire	Pin # Wire	Pin # Wire	Pin # Wire	Pin # Wire	Pin # Wire	Pin # Wire
B	Conn.										
	3P	4P	5P	6P	8P	10P	12P				

Pin Assignments Front View

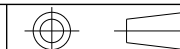
A	UNIT:mm		TITLE N SEN, M12 A, SCREW CABLE W/O SR, F, F, MOLDING			Amphenol LTW			ITEM NO		DRAWN BY		DATE		
	TOLERANCE	±0.5mm	SCALE	SIZE	SHEET	OF	安費諾亮泰企業股份有限公司			DWG NO		CHECKED BY		DATE	
			3:2	A4	2	2				M12A-XXBFFM-SR8NXX		Feng		2022-07-11	
			REV.	WC-REV.	◎: Inspection item					CUSTOMER		APPROVED BY		DATE	
			B	.0						ALTW		Jerry		2022-07-11	