

THIS DOCUMENT IS SUBJECT TO CHANGE WITHOUT NOTICE. IT IS CONFIDENTIAL AND A PROPERTY OF Amphenol LTW. DISCLOSURE TO THIRD PARTY HAS TO BE AUTHORIZED BY Amphenol LTW.

REV.	ECN NO.	DATE	SIGN	DESCRIPTION
B	LEN1720245	2017/02/15	Frank Deng	Change dimension from 34.0 to 34.7
C	C220466	2022/04/12	Ruru	$\triangle C$ X8
D	C230121	2023/02/06	Ruru	$\triangle D$ XI

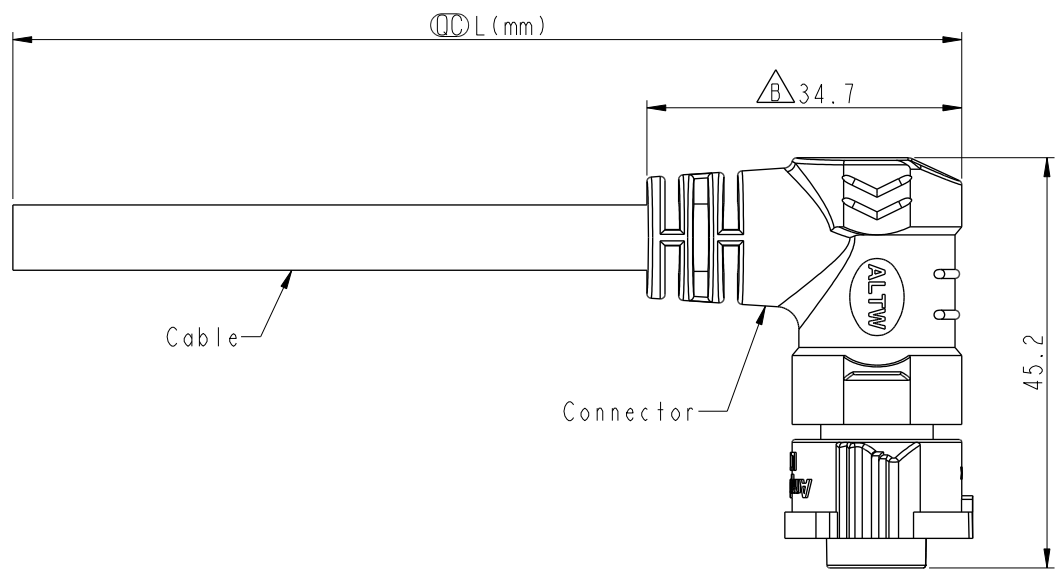

Note: $\triangle C$



- * RoHS Compliant
- * ⌀ Important dimension
- * $\triangle D$ Waterproof rate: IP68, mated 1m/24h
- * Connector
- Housing: Thermoplastic, Black
- Pin: Copper Alloy, Gold Plated
- O-Ring: Rubber, Dark Gray
- Nut: Thermoplastic, Black
- Outer mold: Thermoplastic, Black
- * Cable: UL21388, PVC Jacket, Black
- * Cable length tolerance: 1M: +50/-0 mm
- 1M < L ≤ 3M: +100/-0 mm
- 3M < L ≤ 5M: +150/-0 mm
- 5M < L ≤ 10M: ±100 mm
- 10M < L ≤ 20M: ±200 mm
- 20M < L ≤ 30M: ±300 mm
- 30M < L ≤ 99M: ±500 mm

UNIT: mm		
TOLERANCE		
±0.5 mm		

TITLE XLOK, B-5A, CABLE W/SR F, F, MOLDING, PUSH LOCK $\triangle C$		
SCALE 6:5	SIZE A4	SHEET 1 OF 2
REV. D	WC-REV. A.1	⌀ : Inspection item



Amphenol LTW
安費諾亮泰企業股份有限公司

ITEM NO.	DRAWN BY Frank Deng	DATE 2017-02-15
DWG NO. BD-XXAFFM-QR8DXX $\triangle C$	CHECKED BY Spring Liu	DATE 2017-02-15
CUSTOMER ALTW	APPROVED BY Kevin Hu	DATE 2017-02-15

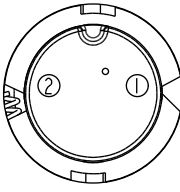
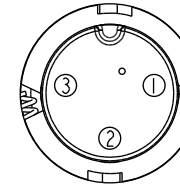
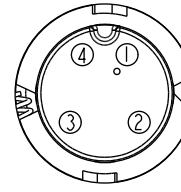
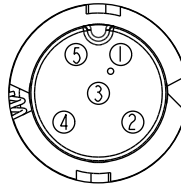
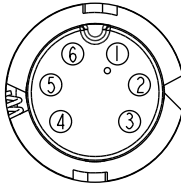
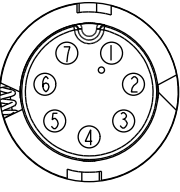
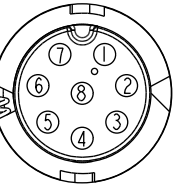
F									<table border="1" style="width: 100%; border-collapse: collapse;"> <tr><td>8P</td><td>7.2</td><td rowspan="8" style="text-align: center; vertical-align: middle;">20</td><td>BD-08AFFM-QR8DXX</td></tr> <tr><td>7P</td><td rowspan="2" style="text-align: center; vertical-align: middle;">6.8</td><td>BD-07AFFM-QR8DXX</td></tr> <tr><td>6P</td><td>BD-06AFFM-QR8DXX</td></tr> <tr><td>5P</td><td>6.2</td><td>BD-05AFFM-QR8DXX</td></tr> <tr><td>4P</td><td>6.0</td><td>BD-04AFFM-QR8DXX</td></tr> <tr><td>3P</td><td rowspan="2" style="text-align: center; vertical-align: middle;">5.5</td><td>BD-03AFFM-QR8DXX</td></tr> <tr><td>2P</td><td>BD-02AFFM-QR8DXX</td></tr> <tr><td>Contacts</td><td>Cable OD</td><td>AWG</td><td>Item No.</td></tr> </table>	8P	7.2	20	BD-08AFFM-QR8DXX	7P	6.8	BD-07AFFM-QR8DXX	6P	BD-06AFFM-QR8DXX	5P	6.2	BD-05AFFM-QR8DXX	4P	6.0	BD-04AFFM-QR8DXX	3P	5.5	BD-03AFFM-QR8DXX	2P	BD-02AFFM-QR8DXX	Contacts	Cable OD	AWG	Item No.
8P	7.2	20	BD-08AFFM-QR8DXX																														
7P	6.8		BD-07AFFM-QR8DXX																														
6P			BD-06AFFM-QR8DXX																														
5P	6.2		BD-05AFFM-QR8DXX																														
4P	6.0		BD-04AFFM-QR8DXX																														
3P	5.5		BD-03AFFM-QR8DXX																														
2P			BD-02AFFM-QR8DXX																														
Contacts	Cable OD		AWG	Item No.																													
E	XX: No. Of Pin XX: 01~99Meters 01: 01Meter 02: 02Meters : 99: 99Meters																																
D																																	

C	Pin Out	2 Brown 棕 1 Black 黑		3 Red 紅 2 Brown 棕 1 Black 黑		4 Orange 橙 3 Red 紅 2 Brown 棕 1 Black 黑		5 Yellow 黃 4 Orange 橙 3 Red 紅 2 Brown 棕 1 Black 黑		6 Green 綠 5 Yellow 黃 4 Orange 橙 3 Red 紅 2 Brown 棕 1 Black 黑		7 Blue 藍 6 Green 綠 5 Yellow 黃 4 Orange 橙 3 Red 紅 2 Brown 棕 1 Black 黑		8 Purple 紫 7 Blue 藍 6 Green 綠 5 Yellow 黃 4 Orange 橙 3 Red 紅 2 Brown 棕 1 Black 黑	
B	Conn.														
		2P	3P	4P	5P	6P	7P	8P							

Pin Assignments Front View

UNIT:mm		TITLE XLOK, B-5A, CABLE W/SR F, F, MOLDING, PUSH LOCK 	<h2 style="margin: 0;">Amphenol LTW</h2> <p style="margin: 0;">安費諾亮泰企業股份有限公司</p>	ITEM NO	DRAWN BY Frank Deng	DATE 2017-02-15		
TOLERANCE ±0.5 mm		SCALE 6:5	SIZE A4	SHEET 2 OF 2	DWG NO BD-XXAFFM-QR8DXX 	CHECKED BY Spring Liu	DATE 2017-02-15	
		REV. D	WC-REV. A.1	 : Inspection item	CUSTOMER ALTW	APPROVED BY Kevin Hu	DATE 2017-02-15	
A	1	2	3	4	5	6	7	8