

THIS DOCUMENT IS SUBJECT TO CHANGE WITHOUT NOTICE. IT IS CONFIDENTIAL AND A PROPERTY OF AMPHENOL LTW. DISCLOSURE TO THIRD PARTY HAS TO BE AUTHORIZED BY AMPHENOL LTW.

REV.	ECN NO.	DATE	SIGN	DESCRIPTION
B	C200611	2020/05/08	Roy	$\triangle B$ XI
C	C220466	2022/04/12	Ruru	$\triangle C$ X8
D	C230121	2023/02/06	Ruru	$\triangle D$ XI

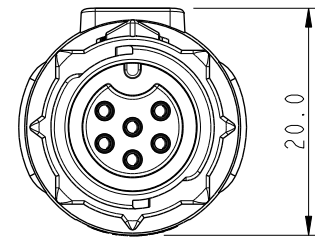
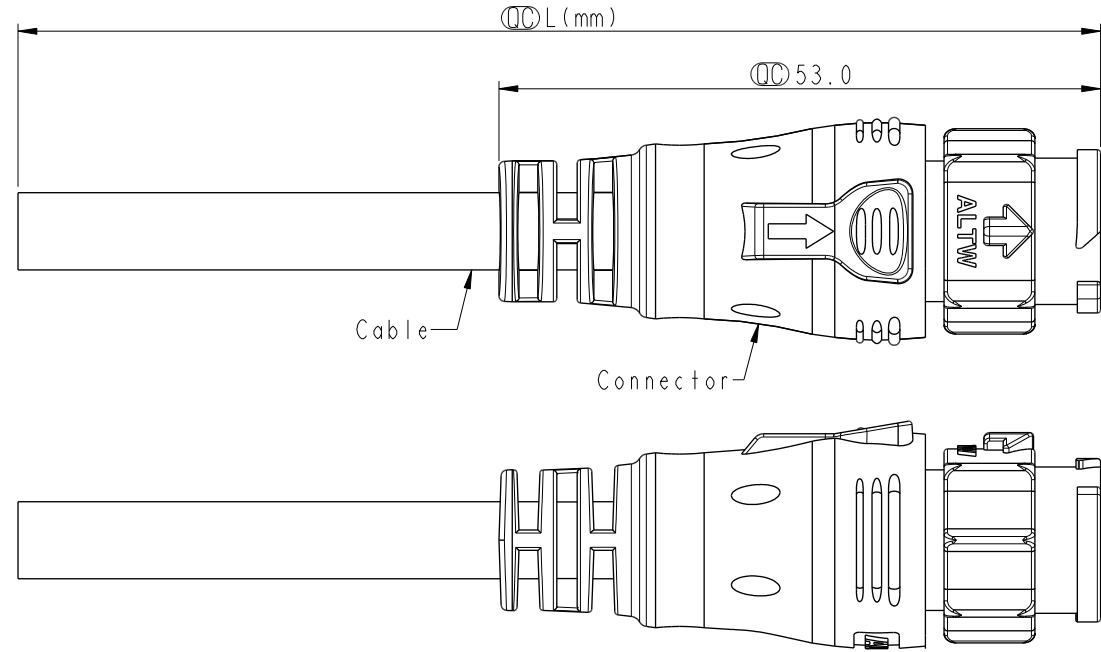

Note: $\triangle C$

- * RoHS Compliant
- * CC Important dimension
- $\triangle D$ * Waterproof rate: IP68, mated 1m/24h
- * Connector
- Housing: Thermoplastic, Black
- Pin: Copper Alloy, Gold Plated
- Outer mold: Thermoplastic, Black
- * Cable: UL21388, PVC Jacket, Black
- * Cable length tolerance: 1M: +50/-0 mm
- 1M < L ≤ 3M: +100/-0 mm
- 3M < L ≤ 5M: +150/-0 mm
- 5M < L ≤ 10M: ±100 mm
- 10M < L ≤ 20M: ±200 mm
- 20M < L ≤ 30M: ±300 mm
- 30M < L ≤ 99M: ±500 mm

UNIT:mm			TITLE XLOK, B-5A, CABLE W/SR M, F, MOLDING, PUSH LOCK $\triangle C$		
TOLERANCE ±0.5 mm			SCALE 3:2	SIZE A4	SHEET 1 OF 2
			REV. D	WC-REV. A.1	CC : Inspection item

Amphenol LTW
安費諾亮泰企業股份有限公司

ITEM NO	DRAWN BY Micky	DATE 2014-10-24
DWG NO BD-XXAMFM-QL8DXX $\triangle C$	CHECKED BY Spring	DATE 2014-10-24
CUSTOMER ALTW	APPROVED BY Kevin	DATE 2014-10-24

THIS DOCUMENT IS SUBJECT TO CHANGE WITHOUT NOTICE. IT IS CONFIDENTIAL AND A PROPERTY OF Amphenol LTW. DISCLOSURE TO THIRD PARTY HAS TO BE AUTHORIZED BY Amphenol LTW.

		8	
6P	6.8	20	BD-06AMFM-QL8DXX
5P	6.2		BD-05AMFM-QL8DXX
4P	6.0		BD-04AMFM-QL8DXX
3P	5.5		BD-03AMFM-QL8DXX
2P	5.5		BD-02AMFM-QL8DXX
Contacts	Cable OD	AWG	Item No.

△
BD-XXAMFM-QL8DXX

XX: No. Of Pin

XX: 01~99Meters
 01: 01Meter
 02: 02Meters
 :
 99: 99Meters

△

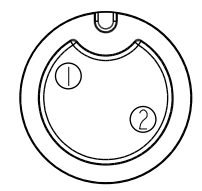
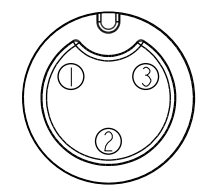
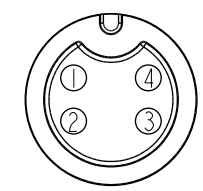
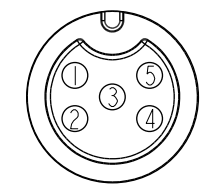
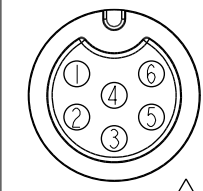
Pin Out	2 Brown 棕 1 Black 黑	3 Red 紅 2 Brown 棕 1 Black 黑	4 Orange 橙 3 Red 紅 2 Brown 棕 1 Black 黑	5 Yellow 黃 4 Orange 橙 3 Red 紅 2 Brown 棕 1 Black 黑	6 Green 綠 5 Yellow 黃 4 Orange 橙 3 Red 紅 2 Brown 棕 1 Black 黑
	Pin # Wire	Pin # Wire	Pin # Wire	Pin # Wire	Pin # Wire
Conn.					
	2P	3P	4P	5P	6P △

Pin Assignments Front View

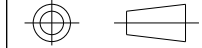
UNIT:mm		TITLE XLOK, B-5A, CABLE W/SR M, F, MOLDING, PUSH LOCK △
TOLERANCE ±0.5 mm	SCALE 3:2	SIZE A4
	REV. D	SHEET 2 OF 2
	WC-REV. A.1	◎: Inspection item

Amphenol LTW
安費諾亮泰企業股份有限公司

ITEM NO	DRAWN BY Micky	DATE 2014-10-24
DWG NO BD-XXAMFM-QL8DXX △	CHECKED BY Spring	DATE 2014-10-24
CUSTOMER ALTW	APPROVED BY Kevin	DATE 2014-10-24