

THIS DOCUMENT IS SUBJECT TO CHANGE WITHOUT NOTICE. IT IS CONFIDENTIAL AND A PROPERTY OF AMPHENOL LTW. DISCLOSURE TO THIRD PARTY HAS TO BE AUTHORIZED BY AMPHENOL LTW.

REV.	ECN NO.	DATE	SIGN	DESCRIPTION
B	C220553	2022/04/06	Vicky	$\triangle B$ XI0
C	C230084	2023/01/30	Vicky	$\triangle C$ XI

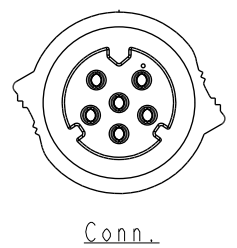
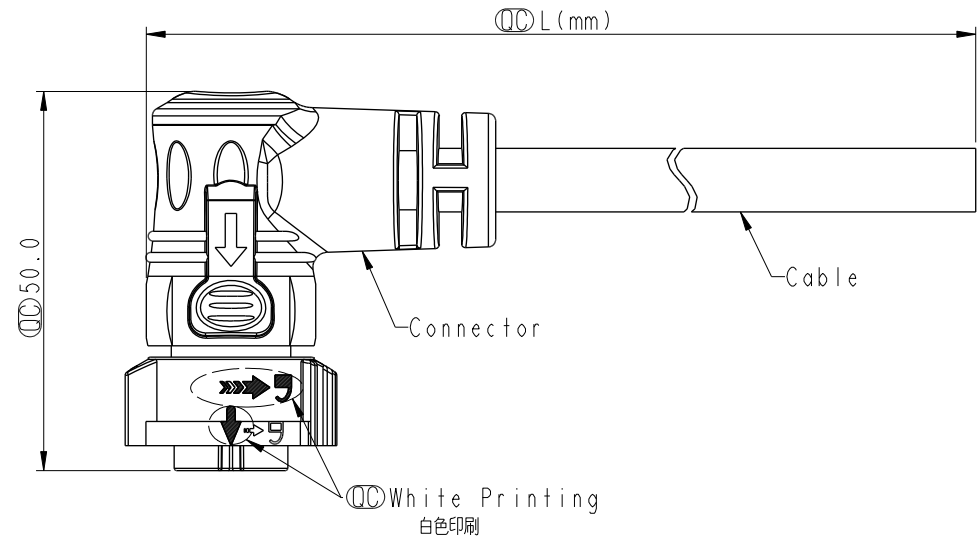

- $\triangle B$
Note:
- * RoHS Compliant
 - * \varnothing Important dimension
 - * $\triangle C$ Waterproof rate: IP68, mated 1m/24h
 - * Connector
 - Housing: Thermoplastic, Black
 - Pin: Copper alloy, Gold plated
 - O-Ring: Rubber, Gray
 - Nut: Thermoplastic, Black
 - Outer mold: Thermoplastic, Black
 - * Cable: UL21388, PVC Jacket, Black
 - * Cable length tolerance:
 - 1M < L ≤ 3M: +100/-0 mm
 - 3M < L ≤ 5M: +150/-0 mm
 - 5M < L ≤ 10M: ±100 mm
 - 10M < L ≤ 20M: ±200 mm
 - 20M < L ≤ 30M: ±300 mm
 - 30M < L ≤ 99M: ±500 mm

A	UNIT: mm			TITLE	$\triangle B$				
	TOLERANCE	$\pm 0.5\text{mm}$		XLOK, C-10A, CABLE W/SR F, F, MOLDING, PUSH LOCK					
	SCALE	1:1	SIZE	A4		SHEET	1	OF	2
	REV.	C	WC-REV.	A.1		\varnothing Inspection item			

Amphenol LTW
安費諾亮泰企業股份有限公司

ITEM NO	DRAWN BY	DATE
	Wes Fan	2016-04-26
DWG NO	CHECKED BY	DATE
CB-XXAFFM-GR8DXX $\triangle B$	Spring Liu	2016-04-26
CUSTOMER	APPROVED BY	DATE
ALTW	Kevin Hu	2016-04-26

THIS DOCUMENT IS SUBJECT TO CHANGE WITHOUT NOTICE. IT IS CONFIDENTIAL AND A PROPERTY OF Amphenol LTW. DISCLOSURE TO THIRD PARTY HAS TO BE AUTHORIZED BY Amphenol LTW.

	6P	8.4	16	CB-06AFFM-QR8DXX
	5P	7.6		CB-05AFFM-QR8DXX
	4P	6.8		CB-04AFFM-QR8DXX
$\triangle B$	Contacts	Cable OD	AWG	Item No.



$\triangle B$
CB-XXAFFM-QR8DXX

XX: No. Of Pin

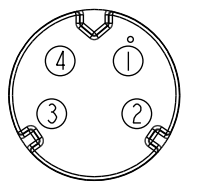
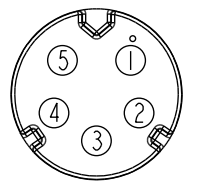
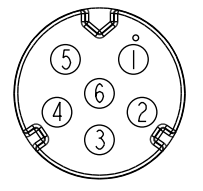
XX: 01~99Meters
 01: 01Meter
 02: 02Meters
 :
 99: 99Meters

Pin Out	4 Orange 橙	5 Yellow 黃	6 Green 綠
	3 Red 紅	4 Orange 橙	5 Yellow 黃
	2 Brown 棕	3 Red 紅	4 Orange 橙
	1 Black 黑	2 Brown 棕	3 Red 紅
		1 Black 黑	2 Brown 棕
			1 Black 黑
	Pin # Wire	Pin # Wire	Pin # Wire
Conn.			
	4P	5P	6P

$\triangle B$ Pin Assignments Front View

UNIT:mm			TITLE XLOK, C-10A, CABLE W/SR F, F, MOLDING, PUSH LOCK	$\triangle B$
TOLERANCE	$\pm 0.5mm$		SCALE 1:1	SIZE A4
	$\triangle B$		SHEET 2	OF 2
	REV. C	WC-REV. A.1	QC: Inspection item	

Amphenol LTW
安費諾亮泰企業股份有限公司

ITEM NO	DRAWN BY Wes Fan	DATE 2016-04-26
DWG NO CB-XXAFFM-QR8DXX $\triangle B$	CHECKED BY Spring Liu	DATE 2016-04-26
CUSTOMER ALTW	APPROVED BY Kevin Hu	DATE 2016-04-26