

THIS DOCUMENT IS SUBJECT TO CHANGE WITHOUT NOTICE. IT IS CONFIDENTIAL AND A PROPERTY OF AMPHENOL LTW. DISCLOSURE TO THIRD PARTY HAS TO BE AUTHORIZED BY AMPHENOL LTW.

REV.	ECN NO.	DATE	SIGN	DESCRIPTION
A		2022-11-01	Allen Pan	Rev.03 To Rev.A
B	C230086	2023-01-31	Ruru	$\triangle B$ XI

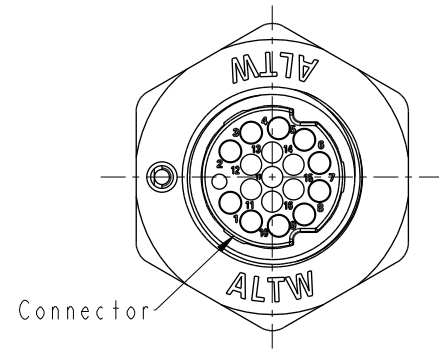
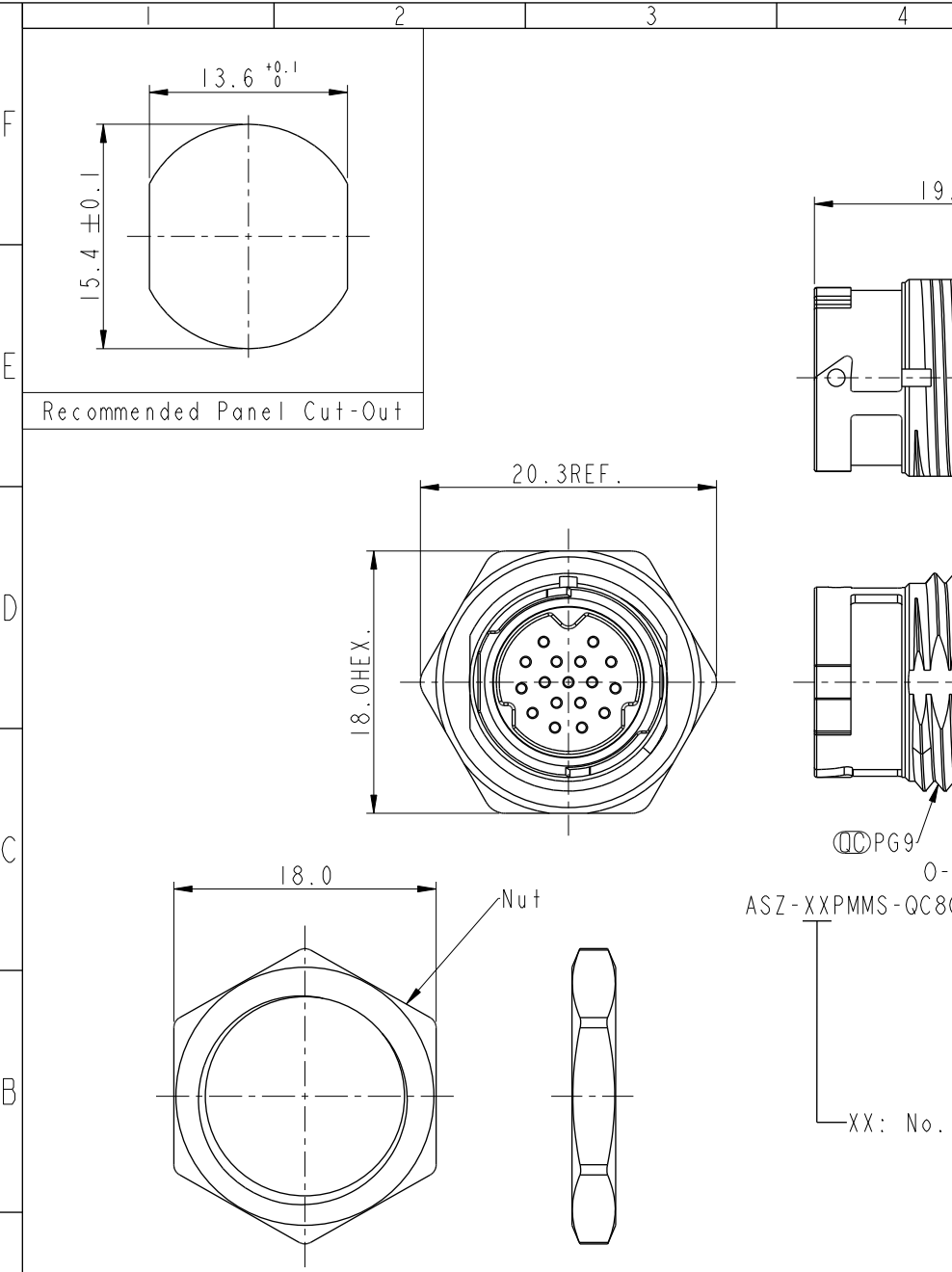

- Note:
- * RoHS Compliant
 - * QC Important Dimension
 - $\triangle B$ * Waterproof Rate: IP68, Unmated 1m/24h
 - * Connector
 - Housing: Thermoplastic, Black
 - Pin: Copper Alloy, Gold plated
 - * Shield: Metal
 - * Nut: Metal
 - * O-Ring: Rubber, Black
 - * Shield Pin: Copper Alloy, Tin plated
 - * For Panel Thickness Max: 4.5mm
 - * Nut is packed separately in pe bag
 - * Wire: UL1061, 26AWG, $\phi 1$
 - * Wire harness tolerance:
- | | |
|----------------------|-------|
| 100mm: | ±10mm |
| 100mm < L ≤ 300mm: | ±15mm |
| 300mm < L ≤ 1000mm: | ±20mm |
| 1000mm < L ≤ 1500mm: | ±50mm |

ASZ-XXPMMS-QC8CXX

XX: L=100~1500mm
 10: L=100mm
 15: L=150mm
 :
 95: L=950mm
 Wire Pitch Unit=50mm

XX: No. Of Pin
 A0: L=1000mm
 A1: L=1100mm
 :
 A5: L=1500mm
 Wire Pitch Unit=100mm

UNIT: mm			TITLE XLOK, A SHLD-1.5A, FRONT FASTENED M, M, SOLDER, PUSH LOCK
TOLERANCE ±0.50mm	SCALE 2:1	SIZE A4	SHEET 1 OF 2
REV. B	WC-REV.	QC : Inspection item	

ITEM NO.		DRAWN BY Allen Pan	DATE 2022-11-01
DWG NO. ASZ-XXPMMS-QC8CXX		CHECKED BY Sam Ho	DATE 2022-11-01
CUSTOMER ALTW		APPROVED BY Fred Lee	DATE 2022-11-01

THIS DOCUMENT IS SUBJECT TO CHANGE WITHOUT NOTICE. IT IS CONFIDENTIAL AND A PROPERTY OF AMPHENOL LTW. DISCLOSURE TO THIRD PARTY HAS TO BE AUTHORIZED BY AMPHENOL LTW.

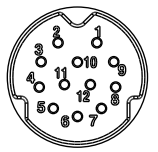
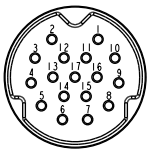
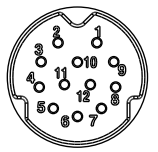
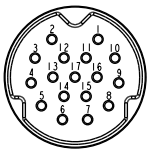
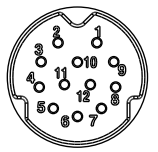
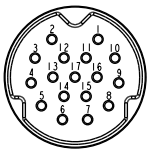
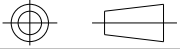
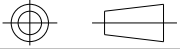
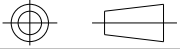
1	2	3	4	5	6	7	8																																																																																																																																																
F																																																																																																																																																							
E																																																																																																																																																							
D	<table border="1" style="width: 100%; border-collapse: collapse;"> <tr> <td style="width: 15%;"></td> <td style="width: 15%;">12 Red/Blue 紅/藍</td> <td style="width: 15%;">17 White/Gray 白/灰</td> <td style="width: 15%;"></td> <td style="width: 15%;">12 Red/Blue 紅/藍</td> <td style="width: 15%;"></td> <td style="width: 15%;"></td> <td style="width: 15%;"></td> </tr> <tr> <td></td> <td>11 Gray/Pink 灰/粉紅</td> <td>16 Yellow/Brown 黃/棕</td> <td></td> <td>11 Gray/Pink 灰/粉紅</td> <td></td> <td></td> <td></td> </tr> <tr> <td></td> <td>10 Violet 紫</td> <td>15 White/Yellow 白/黃</td> <td></td> <td>10 Violet 紫</td> <td></td> <td></td> <td></td> </tr> <tr> <td></td> <td>9 Black 黑</td> <td>14 Brown/Green 棕/綠</td> <td></td> <td>9 Red 紅</td> <td></td> <td></td> <td></td> </tr> <tr> <td></td> <td>8 Red 紅</td> <td>13 White/Green 白/綠</td> <td></td> <td>8 Gray 灰</td> <td></td> <td></td> <td></td> </tr> <tr> <td></td> <td>7 Blue 藍</td> <td>12 Red/Blue 紅/藍</td> <td></td> <td>7 Black 黑</td> <td></td> <td></td> <td></td> </tr> <tr> <td></td> <td>6 Pink 粉紅</td> <td>11 Gray/Pink 灰/粉紅</td> <td></td> <td>6 Yellow 黃</td> <td></td> <td></td> <td></td> </tr> <tr> <td></td> <td>5 Gray 灰</td> <td>10 Violet 紫</td> <td></td> <td>5 Pink 粉紅</td> <td></td> <td></td> <td></td> </tr> <tr> <td></td> <td>4 Yellow 黃</td> <td>9 Red 紅</td> <td></td> <td>4 Green 綠</td> <td></td> <td></td> <td></td> </tr> <tr> <td></td> <td>3 Green 綠</td> <td>8 Gray 灰</td> <td></td> <td>3 White 白</td> <td></td> <td></td> <td></td> </tr> <tr> <td></td> <td>2 Brown 棕</td> <td>7 Black 黑</td> <td></td> <td>2 Blue 藍</td> <td></td> <td></td> <td></td> </tr> <tr> <td></td> <td>1 White 白</td> <td>6 Yellow 黃</td> <td></td> <td>1 Brown 棕</td> <td></td> <td></td> <td></td> </tr> <tr> <td></td> <td></td> <td>5 Pink 粉紅</td> <td></td> <td></td> <td></td> <td></td> <td></td> </tr> <tr> <td></td> <td></td> <td>4 Green 綠</td> <td></td> <td></td> <td></td> <td></td> <td></td> </tr> <tr> <td></td> <td></td> <td>3 White 白</td> <td></td> <td></td> <td></td> <td></td> <td></td> </tr> <tr> <td></td> <td></td> <td>2 Blue 藍</td> <td></td> <td></td> <td></td> <td></td> <td></td> </tr> <tr> <td></td> <td></td> <td>1 Brown 棕</td> <td></td> <td></td> <td></td> <td></td> <td></td> </tr> <tr> <td></td> <td style="text-align: center;">Pin #</td> <td style="text-align: center;">Wire</td> <td></td> <td style="text-align: center;">Pin #</td> <td style="text-align: center;">Wire</td> <td></td> <td></td> </tr> </table>								12 Red/Blue 紅/藍	17 White/Gray 白/灰		12 Red/Blue 紅/藍					11 Gray/Pink 灰/粉紅	16 Yellow/Brown 黃/棕		11 Gray/Pink 灰/粉紅					10 Violet 紫	15 White/Yellow 白/黃		10 Violet 紫					9 Black 黑	14 Brown/Green 棕/綠		9 Red 紅					8 Red 紅	13 White/Green 白/綠		8 Gray 灰					7 Blue 藍	12 Red/Blue 紅/藍		7 Black 黑					6 Pink 粉紅	11 Gray/Pink 灰/粉紅		6 Yellow 黃					5 Gray 灰	10 Violet 紫		5 Pink 粉紅					4 Yellow 黃	9 Red 紅		4 Green 綠					3 Green 綠	8 Gray 灰		3 White 白					2 Brown 棕	7 Black 黑		2 Blue 藍					1 White 白	6 Yellow 黃		1 Brown 棕						5 Pink 粉紅								4 Green 綠								3 White 白								2 Blue 藍								1 Brown 棕							Pin #	Wire		Pin #	Wire		
	12 Red/Blue 紅/藍	17 White/Gray 白/灰		12 Red/Blue 紅/藍																																																																																																																																																			
	11 Gray/Pink 灰/粉紅	16 Yellow/Brown 黃/棕		11 Gray/Pink 灰/粉紅																																																																																																																																																			
	10 Violet 紫	15 White/Yellow 白/黃		10 Violet 紫																																																																																																																																																			
	9 Black 黑	14 Brown/Green 棕/綠		9 Red 紅																																																																																																																																																			
	8 Red 紅	13 White/Green 白/綠		8 Gray 灰																																																																																																																																																			
	7 Blue 藍	12 Red/Blue 紅/藍		7 Black 黑																																																																																																																																																			
	6 Pink 粉紅	11 Gray/Pink 灰/粉紅		6 Yellow 黃																																																																																																																																																			
	5 Gray 灰	10 Violet 紫		5 Pink 粉紅																																																																																																																																																			
	4 Yellow 黃	9 Red 紅		4 Green 綠																																																																																																																																																			
	3 Green 綠	8 Gray 灰		3 White 白																																																																																																																																																			
	2 Brown 棕	7 Black 黑		2 Blue 藍																																																																																																																																																			
	1 White 白	6 Yellow 黃		1 Brown 棕																																																																																																																																																			
		5 Pink 粉紅																																																																																																																																																					
		4 Green 綠																																																																																																																																																					
		3 White 白																																																																																																																																																					
		2 Blue 藍																																																																																																																																																					
		1 Brown 棕																																																																																																																																																					
	Pin #	Wire		Pin #	Wire																																																																																																																																																		
C																																																																																																																																																							
B	<table border="1" style="width: 100%; border-collapse: collapse;"> <tr> <td style="width: 50%; text-align: center;">  <p>12P</p> </td> <td style="width: 50%; text-align: center;">  <p>17P</p> </td> </tr> <tr> <td colspan="2" style="text-align: center;">Pin Assignments Front View</td> </tr> </table>							 <p>12P</p>	 <p>17P</p>	Pin Assignments Front View																																																																																																																																													
 <p>12P</p>	 <p>17P</p>																																																																																																																																																						
Pin Assignments Front View																																																																																																																																																							
A	<table border="1" style="width: 100%; border-collapse: collapse;"> <tr> <td style="width: 15%;">UNIT:mm</td> <td style="width: 15%; text-align: center;">  </td> <td style="width: 30%;"> TITLE XL0K, A SHLD-1.5A, FRONT FASTENED M, M, SOLDER, PUSH LOCK </td> <td style="width: 20%; text-align: center; vertical-align: middle;"> <h1 style="margin: 0;">Amphenol LTW</h1> <p style="margin: 0;">安費諾亮泰企業股份有限公司</p> </td> <td style="width: 10%;">ITEM NO</td> <td style="width: 10%;">DRAWN BY</td> <td style="width: 10%;">DATE</td> </tr> <tr> <td colspan="2">TOLERANCE</td> <td>SCALE 2:1</td> <td>SIZE A4</td> <td>SHEET 2 OF 2</td> <td>DWG NO ASZ-XXPMMS-QC8CXX</td> <td>CHECKED BY Sam Ho</td> <td>DATE 2022-11-01</td> </tr> <tr> <td colspan="2" style="text-align: center;">±0.50mm</td> <td>REV. B</td> <td>WC-REV.</td> <td style="text-align: center;">QC: Inspection item</td> <td>CUSTOMER ALTW</td> <td>APPROVED BY Fred Lee</td> <td>DATE 2022-11-01</td> </tr> </table>							UNIT:mm		TITLE XL0K, A SHLD-1.5A, FRONT FASTENED M, M, SOLDER, PUSH LOCK	<h1 style="margin: 0;">Amphenol LTW</h1> <p style="margin: 0;">安費諾亮泰企業股份有限公司</p>	ITEM NO	DRAWN BY	DATE	TOLERANCE		SCALE 2:1	SIZE A4	SHEET 2 OF 2	DWG NO ASZ-XXPMMS-QC8CXX	CHECKED BY Sam Ho	DATE 2022-11-01	±0.50mm		REV. B	WC-REV.	QC: Inspection item	CUSTOMER ALTW	APPROVED BY Fred Lee	DATE 2022-11-01																																																																																																																									
UNIT:mm		TITLE XL0K, A SHLD-1.5A, FRONT FASTENED M, M, SOLDER, PUSH LOCK	<h1 style="margin: 0;">Amphenol LTW</h1> <p style="margin: 0;">安費諾亮泰企業股份有限公司</p>	ITEM NO	DRAWN BY	DATE																																																																																																																																																	
TOLERANCE		SCALE 2:1	SIZE A4	SHEET 2 OF 2	DWG NO ASZ-XXPMMS-QC8CXX	CHECKED BY Sam Ho	DATE 2022-11-01																																																																																																																																																
±0.50mm		REV. B	WC-REV.	QC: Inspection item	CUSTOMER ALTW	APPROVED BY Fred Lee	DATE 2022-11-01																																																																																																																																																
1	2	3	4	5	6	7	8																																																																																																																																																