

THIS DOCUMENT IS SUBJECT TO CHANGE WITHOUT NOTICE. IT IS CONFIDENTIAL AND A PROPERTY OF Amphenol LTW. DISCLOSURE TO THIRD PARTY HAS TO BE AUTHORIZED BY Amphenol LTW.

REV.	ECN NO.	DATE	SIGN	DESCRIPTION
B	C230419	2023/03/29	Vicky	$\triangle B$ X5

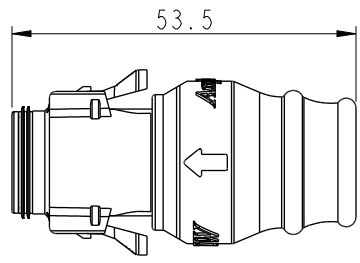

Conn.

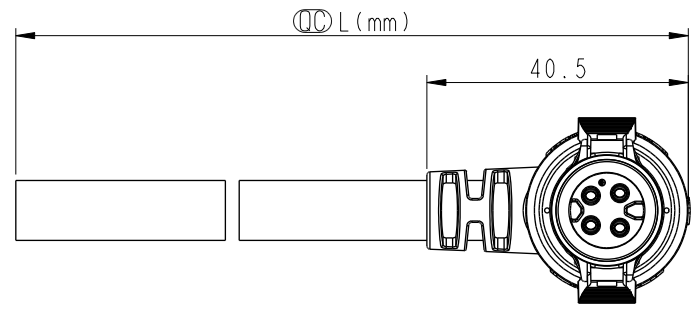
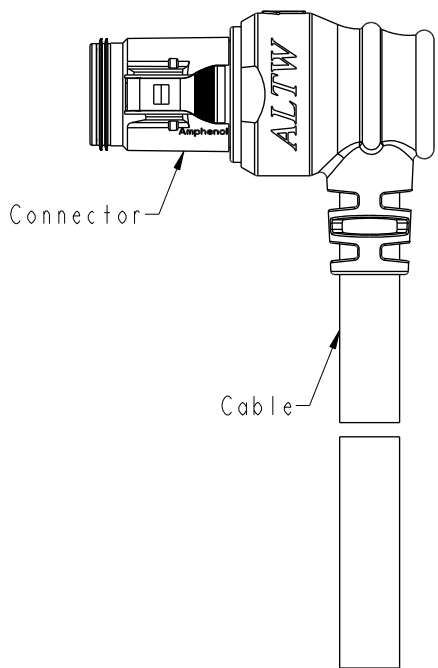

- $\triangle B$ Note:
- * RoHS Compliant
 - * $\text{\textcircled{C}}$ Important dimension
 - * Waterproof rate: IP68, mated 1m/24h
 - * Connector
 - Housing: Thermoplastic, Black
 - Pin: Copper alloy, Gold plated
 - O-Ring: Rubber, Gray
 - Gasket: Rubber, Gray
 - Outer mold: Thermoplastic, Black
 - * Cable: SJTW, PVC Jacket, Black
 - * Cable length tolerance:
 - 1M < L \leq 3M: +100/-0 mm
 - 3M < L \leq 5M: +150/-0 mm
 - 5M < L \leq 10M: \pm 100 mm
 - 10M < L \leq 20M: \pm 200 mm
 - 20M < L \leq 30M: \pm 300 mm
 - 30M < L \leq 99M: \pm 500 mm

UNIT: mm		
TOLERANCE		
$\pm 0.5\text{mm}$		

TITLE RBL, C-10A, CABLE W/SR M, F, MOLDING, RBL			$\triangle B$
SCALE 1:1	SIZE A4	SHEET 1 OF 2	
REV. B	WC-REV. A.5	$\text{\textcircled{C}}$: Inspection item	

Amphenol LTW
安費諾亮泰企業股份有限公司

ITEM NO	DRAWN BY Peng	DATE 2019-03-22
DWG NO CB-XXAMFM-RR8EXX	CHECKED BY Mafei	DATE 2019-03-22
CUSTOMER ALTW	APPROVED BY Jerry	DATE 2019-03-22

THIS DOCUMENT IS SUBJECT TO CHANGE WITHOUT NOTICE. IT IS CONFIDENTIAL AND A PROPERTY OF Amphenol LTW. DISCLOSURE TO THIRD PARTY HAS TO BE AUTHORIZED BY Amphenol LTW.

	4P	9.3	16	CB-04AMFM-RR8EXX
	3P	8.6		CB-03AMFM-RR8EXX
	2P	8.2		CB-02AMFM-RR8EXX
△B	Contacts	Cable OD	AWG	Item No.

△B CB-XXAMFM-RR8EXX

XX: No. Of Pin

XX: 01~99Meters
 01: 01Meter
 02: 02Meters
 :
 99: 99Meters

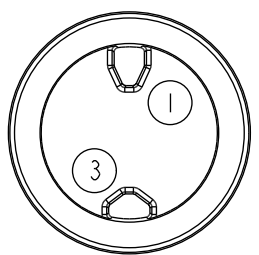
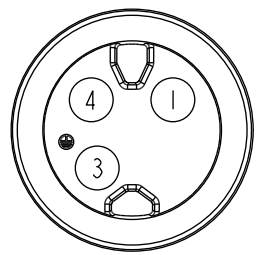
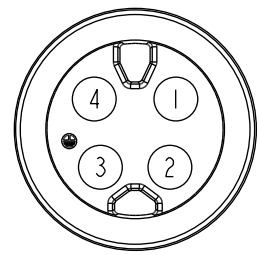
C	Pin Out	4 -- 3 White 白 2 -- 1 Black 黑	4 Green 綠 3 White 白 2 -- 1 Black 黑	4 Green 綠 3 White 白 2 Red 紅 1 Black 黑
	Conn.			
		2P	3P	4P

Pin Assignments Front View

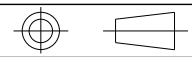
A	UNIT:mm		TITLE	RBL, C-10A, CABLE W/SR M, F, MOLDING, RBL	△B					
	TOLERANCE	±0.5mm	SCALE	1:1	SIZE	A4	SHEET	2	OF	2
			REV.	B	WC-REV.	A.5	◎: Inspection item			

Amphenol LTW
 安費諾亮泰企業股份有限公司

ITEM NO	CB-XXAMFM-RR8EXX	DRAWN BY	Peng	DATE	2019-03-22
DWG NO	CB-XXAMFM-RR8EXX	CHECKED BY	Mafei	DATE	2019-03-22
CUSTOMER	ALTW	APPROVED BY	Jerry	DATE	2019-03-22