

THIS DOCUMENT IS SUBJECT TO CHANGE WITHOUT NOTICE. IT IS CONFIDENTIAL AND A PROPERTY OF Amphenol LTW. DISCLOSURE TO THIRD PARTY HAS TO BE AUTHORIZED BY Amphenol LTW.

REV.	ECN NO.	DATE	SIGN	DESCRIPTION
C	LEN1680342,356-57	2016/08/06	Mafei	Updated The Pin Out Color.
D	LE31740041~43	2017/03/27	Mafei	Updated The Connector
E	C230419	2023/03/30	Vicky	$\triangle E$ X5

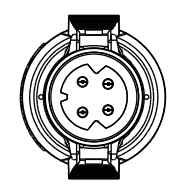
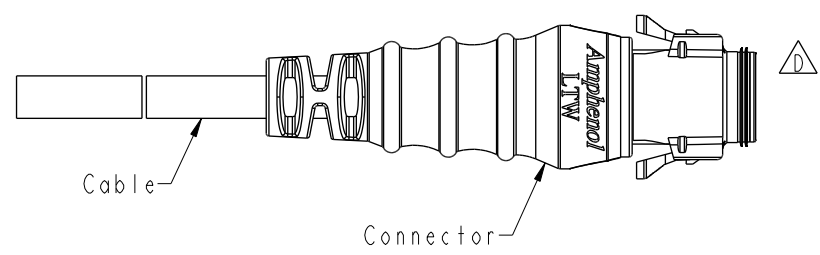
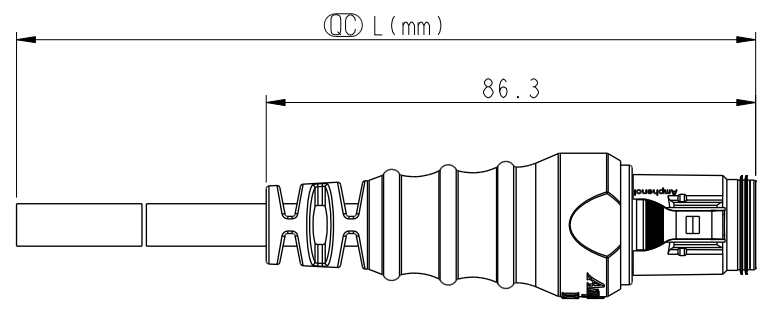

Conn.

- $\triangle E$ Note:
- * RoHS Compliant
 - * \varnothing Important dimension
 - * Waterproof rate: IP67, mated
 - * Connector
 - Housing: Thermoplastic, Black
 - Pin: Copper alloy, Gold plated
 - O-Ring: Rubber, Gray
 - Gasket: Rubber, Gray
 - Outer mold: Thermoplastic, Black
 - * Cable: UL2464, PVC Jacket, Black
 - * Cable length tolerance: 1M: +50/-0 mm

1M < L ≤ 3M:	+100/-0 mm
3M < L ≤ 5M:	+150/-0 mm
5M < L ≤ 10M:	±100 mm
10M < L ≤ 20M:	±200 mm
20M < L ≤ 30M:	±300 mm
30M < L ≤ 99M:	±500 mm

UNIT:mm			TITLE	$\triangle E$
TOLERANCE	±0.5mm		RBL, C-10A, CABLE W/SR M, M, MOLDING, RBL	
SCALE	1:1	SIZE	A4	SHEET 1 OF 2
REV.	E	WC-REV.	A.4	\varnothing : Inspection item

Amphenol LTW
安費諾亮泰企業股份有限公司

ITEM NO	DRAWN BY	DATE
	Mafei	2017-03-27
DWG NO	CHECKED BY	DATE
CB-XXAMMM-RL7AXX	Jerry	2017-03-27
CUSTOMER	APPROVED BY	DATE
ALTW	Max	2017-03-27

THIS DOCUMENT IS SUBJECT TO CHANGE WITHOUT NOTICE. IT IS CONFIDENTIAL AND A PROPERTY OF Amphenol LTW. DISCLOSURE TO THIRD PARTY HAS TO BE AUTHORIZED BY Amphenol LTW.

4P		7.5	16	CB-04AMMM-RL7AXX
3P		7.5		CB-03AMMM-RL7AXX
2P		7.8		CB-02AMMM-RL7AXX
Contacts	Cable OD	AWG	Item No.	

CB-XXAMMM-RL7AXX

△ XX: No. Of Pin
 XX: 01~99Meters
 01: 01Meter
 02: 02Meters
 :
 99: 99Meters

Pin Out	4	--	4	Green	綠	4	Orange	橘	
	3	Red	紅	3	White	白	3	Red	紅
	2	--	2	--		2	Brown	棕	
	1	Black	黑	1	Black	黑	1	Black	黑

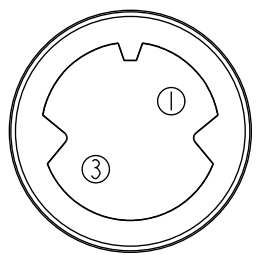
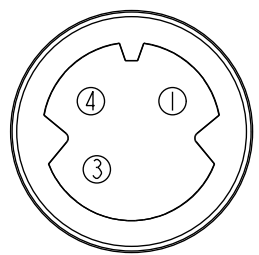
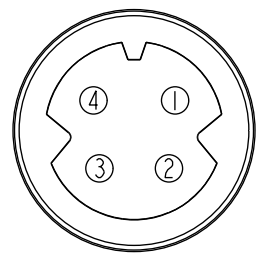
Conn.			
	2P	3P	4P

Pin Assignments Front View

UNIT:mm		TITLE	RBL, C-10A, CABLE W/SR M, M, MOLDING, RBL
TOLERANCE	±0.5mm	SCALE	1:1
		SIZE	A4
		SHEET	2 OF 2
		REV.	E
		WC-REV.	A.4
		☉: Inspection item	

Amphenol LTW
 安費諾亮泰企業股份有限公司

ITEM NO	DRAWN BY	DATE
DWG NO	CHECKED BY	DATE
CUSTOMER	APPROVED BY	DATE
ALTW	Mafei Jerry Max	2017-03-27 2017-03-27 2017-03-27