

THIS DOCUMENT IS SUBJECT TO CHANGE WITHOUT NOTICE. IT IS CONFIDENTIAL AND A PROPERTY OF Amphenol LTW. DISCLOSURE TO THIRD PARTY HAS TO BE AUTHORIZED BY Amphenol LTW.

REV.	ECN NO.	DATE	SIGN	DESCRIPTION
B	C230419	2023/03/29	Vicky	$\triangle B$ X5

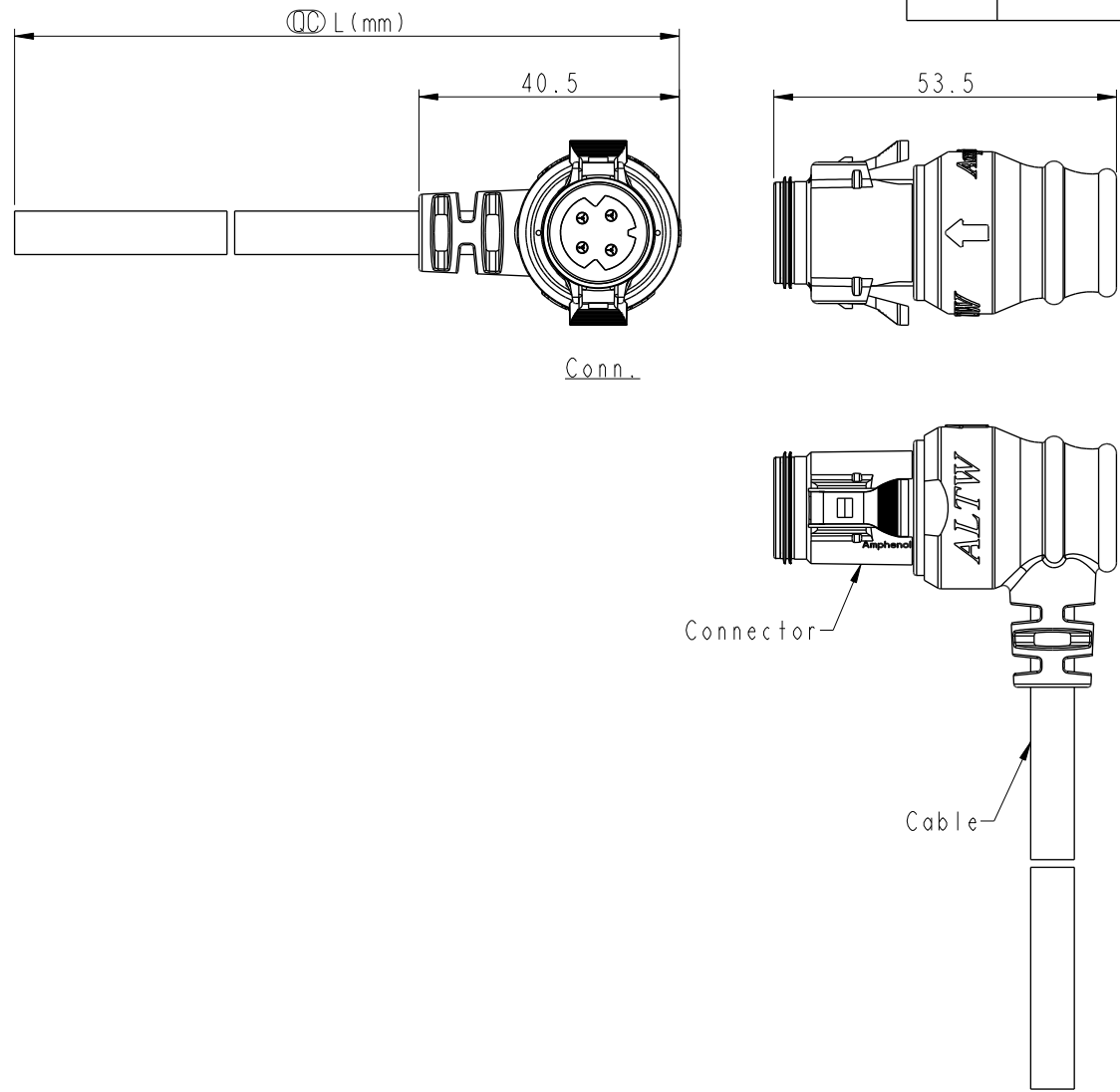

- $\triangle B$  Note:
- \* RoHS Compliant
  - \*  $\text{⌀}$  Important dimension
  - \* Waterproof rate: IP68, mated 1m/24h
  - \* Connector
    - Housing: Thermoplastic, Black
    - Pin: Copper alloy, Gold plated
    - O-Ring: Rubber, Gray
    - Gasket: Rubber, Gray
    - Outer mold: Thermoplastic, Black
  - \* Cable: UL21388, PVC Jacket, Black
  - \* Cable length tolerance:
    - 1M < L ≤ 3M: +100/-0 mm
    - 3M < L ≤ 5M: +150/-0 mm
    - 5M < L ≤ 10M: ±100 mm
    - 10M < L ≤ 20M: ±200 mm
    - 20M < L ≤ 30M: ±300 mm
    - 30M < L ≤ 99M: ±500 mm

UNIT: mm	$\text{⌀}$	$\text{⌀}$
TOLERANCE	±0.5mm	

TITLE RBL, C-10A, CABLE W/SR M, M, MOLDING, RBL			$\triangle B$
SCALE 1:1	SIZE A4	SHEET 1 OF 2	
REV. B	WC-REV. A.5	$\text{⌀}$ : Inspection item	

**Amphenol LTW**  
安費諾亮泰企業股份有限公司

ITEM NO.	DRAWN BY Peng	DATE 2019-03-30
DWG NO. CB-XXAMMM-RR8DXX	CHECKED BY Mafei	DATE 2019-03-30
CUSTOMER ALTW	APPROVED BY Jerry	DATE 2019-03-30



THIS DOCUMENT IS SUBJECT TO CHANGE WITHOUT NOTICE. IT IS CONFIDENTIAL AND A PROPERTY OF Amphenol LTW. DISCLOSURE TO THIRD PARTY HAS TO BE AUTHORIZED BY Amphenol LTW.

4P		6.8	16	CB-04AMMM-RR8DXX
3P		6.5		CB-03AMMM-RR8DXX
2P		6.0		CB-02AMMM-RR8DXX
Contacts	Cable OD	AWG	Item No.	

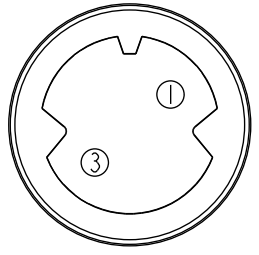
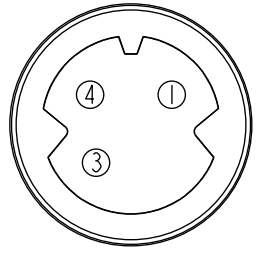
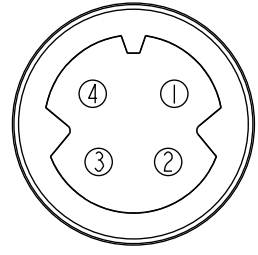
 CB-XXAMMM-RR8DXX  
 XX: No. Of Pin      XX: 01~99Meters  
                                  01: 01Meter  
                                  02: 02Meters  
                                  :  
                                  99: 99Meters

Pin Out	4	--	4	Brown	棕	4	Brown	棕
	3	Red	3	Red	紅	3	Red	紅
	2	--	2	--		2	Orange	橘
	1	Black	1	Black	黑	1	Black	黑
Conn.								
	2P		3P		4P			

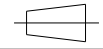
Pin Assignments Front View

UNIT: mm			TITLE	
TOLERANCE	±0.5mm		RBL, C-10A, CABLE W/SR M, M, MOLDING, RBL	
SCALE	1:1	SIZE	A4	SHEET 2 OF 2
REV.	B	WC-REV.	A.5	 : Inspection item

**Amphenol LTW**  
 安費諾亮泰企業股份有限公司

ITEM NO	DRAWN BY	DATE
DWG NO	CHECKED BY	DATE
CUSTOMER	APPROVED BY	DATE
	Peng	2019-03-30
CB-XXAMMM-RR8DXX	Mafei	2019-03-30
ALTW	Jerry	2019-03-30