

THIS DOCUMENT IS SUBJECT TO CHANGE WITHOUT NOTICE. IT IS CONFIDENTIAL AND A PROPERTY OF Amphenol LTW. DISCLOSURE TO THIRD PARTY HAS TO BE AUTHORIZED BY Amphenol LTW.

| REV. | ECN NO. | DATE | SIGN | DESCRIPTION |
|------|----------------|------------|-------|------------------------------|
| B | LEN1580339-41 | 2015/08/20 | Lu Di | Change To Comon Drawing |
| C | LEN1590399-401 | 2015/09/18 | Joyy | Modify The Housing Structure |
| D | C230237 | 2023/03/02 | Vicky | $\triangle D$ X5 |

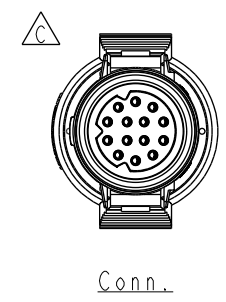

- $\triangle D$ Note:
- * RoHS Compliant
 - * $\text{\textcircled{L}}$ Important dimension
 - * Waterproof rate: IP67, mated
 - * Connector
 - Housing: Thermoplastic, Black
 - Pin: Copper alloy, Gold plated
 - O-Ring: Rubber, Gray
 - Gasket: Rubber, Gray
 - Outer mold: Thermoplastic, Black
 - * Cable: UL2464, PVC Jacket, Black
 - * Cable length tolerance:

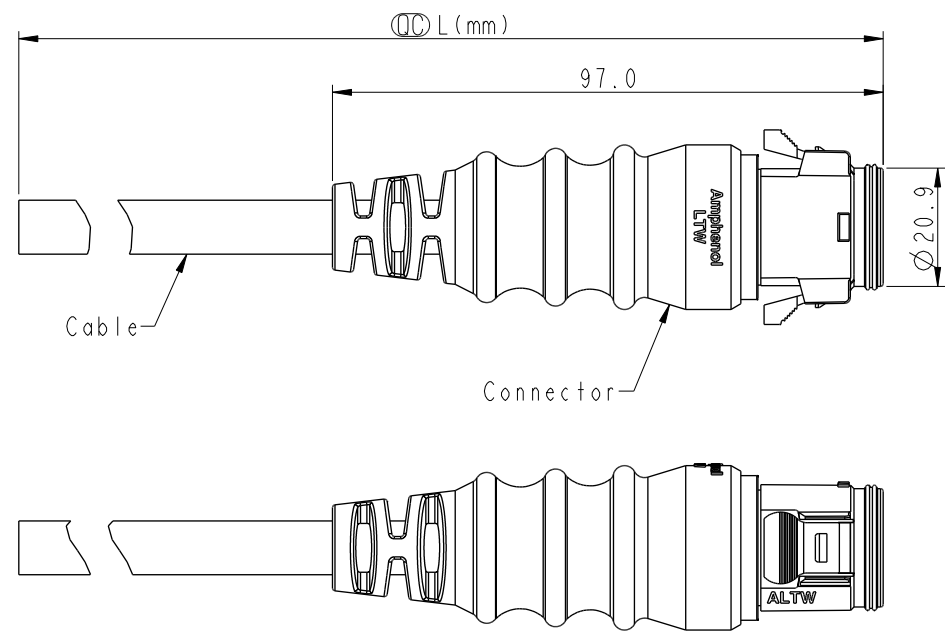



| | |
|----------------|------------|
| 1M < L ≤ 3M: | +100/-0 mm |
| 3M < L ≤ 5M: | +150/-0 mm |
| 5M < L ≤ 10M: | ±100 mm |
| 10M < L ≤ 20M: | ±200 mm |
| 20M < L ≤ 30M: | ±300 mm |
| 30M < L ≤ 99M: | ±500 mm |

| | | | |
|-----------|-----------|---|-----------------|
| UNIT:mm | | TITLE | $\triangle D$ |
| TOLERANCE | ± 0.5 | RBL, D-5A, CABLE W/SR M, F, MOLDING, RBL | |
| SCALE | 3:4 | SIZE | A4 |
| REV. | D | WC-REV. | A.7 |
| | | SHEET | 1 OF 2 |
| | | $\text{\textcircled{L}}$ | Inspection item |

Amphenol LTW
安費諾亮泰企業股份有限公司

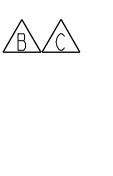
| | | | | | | |
|---------|------------------|----------|----------|------------|-------------|------------|
| ITEM NO | DWG NO | CUSTOMER | DRAWN BY | CHECKED BY | APPROVED BY | DATE |
| | DD-XXAMFM-RL7AXX | ALTW | Lu Di | Joyy | Jerry | 2015-09-18 |
| | | | | | | 2015-09-18 |
| | | | | | | 2015-09-18 |

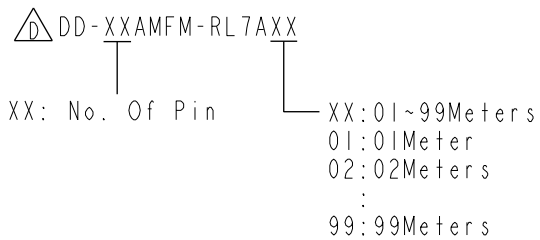
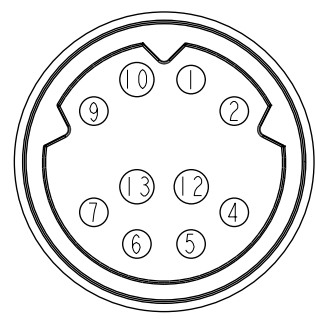
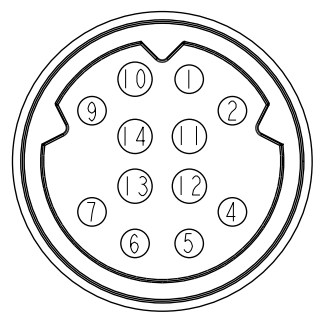
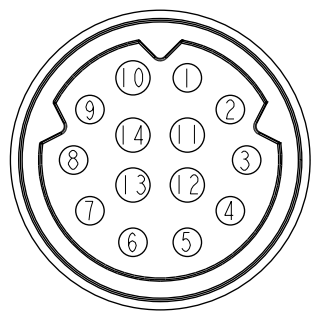
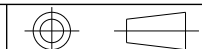
THIS DOCUMENT IS SUBJECT TO CHANGE WITHOUT NOTICE. IT IS CONFIDENTIAL AND A PROPERTY OF AMPHENOL LTW. DISCLOSURE TO THIRD PARTY HAS TO BE AUTHORIZED BY AMPHENOL LTW.

| | | | | | | | | | | | | | | |
|--------------|--|--|---|--------------|--|--|---|------|--|-------|-------------|------------------|------------|--|
| | | | | | | | | | | | | | | |
| F |  | | | | | 14P | 9.5 | 20 | DD-14AMFM-RL7AXX | | | | | |
| | | | | | | 12P | 9.0 | | DD-12AMFM-RL7AXX | | | | | |
| | | | | | | 10P | 9.0 | | DD-10AMFM-RL7AXX | | | | | |
| | | | | | |  Contacts | Cable OD | AWG | Item No. | | | | | |
| E | D | Pin Out | 14 -- | 14 Pink(粉紅) | 14 Black/white(黑/白) |  <p>XX: No. Of Pin XX: 01~99Meters 01: 01Meter 02: 02Meters . 99: 99Meters</p> | | | | | | | | |
| | | | 13 Purple(紫) | 13 Purple(紫) | 13 Brown/White(棕/白) | | | | | | | | | |
| 12 Brown(棕) | 12 Brown(棕) | 12 Light Green(淺綠) | | | | | | | | | | | | |
| 11 -- | 11 Black/white (黑/白) | 11 Pink(粉紅) | | | | | | | | | | | | |
| 10 Orange(橘) | 10 Orange(橘) | 10 Purple(紫) | | | | | | | | | | | | |
| 9 Yellow(黃) | 9 Yellow(黃) | 9 Brown(棕) | | | | | | | | | | | | |
| 8 -- | 8 -- | 8 Orange(橘) | | | | | | | | | | | | |
| 7 Gray(灰) | 7 Gray(灰) | 7 Yellow(黃) | | | | | | | | | | | | |
| 6 Red(紅) | 6 Red(紅) | 6 Gray(灰) | | | | | | | | | | | | |
| 5 Green(綠) | 5 Green(綠) | 5 Red(紅) | | | | | | | | | | | | |
| 4 Blue(藍) | 4 Blue(藍) | 4 Green(綠) | | | | | | | | | | | | |
| 3 -- | 3 -- | 3 Blue(藍) | | | | | | | | | | | | |
| 2 White(白) | 2 White(白) | 2 White(白) | | | | | | | | | | | | |
| 1 Black(黑) | 1 Black(黑) | 1 Black(黑) | | | | | | | | | | | | |
| B | Conn. |  | | |  | | | |  | | | | | |
| | | 10P | | | 12P | | | | 14P | | | | | |
| | | Pin Assignments Front View | | | | | | | | | | | | |
| A | UNIT: mm | |  | | TITLE | | | |  | | ITEM NO | | DRAWN BY | |
| | TOLERANCE | | RBL, D-5A, CABLE W/SR M, F, MOLDING, RBL | | SCALE | | SIZE | | DWG NO | | CHECKED BY | | DATE | |
| | ±0.5 | | 3:4 | | A4 | | SHEET 2 OF 2 | | DD-XXAMFM-RL7AXX | | Joyy | | 2015-09-18 | |
| | | | REV. D | | WC-REV. A.7 | |  Inspection item | | CUSTOMER | | APPROVED BY | | DATE | |
| | | | | | | | | ALTW | | Jerry | | 2015-09-18 | | |
| | | | | | | | | | | | | 8 W10814-03-01A2 | | |

Amphenol LTW

安費諾亮泰企業股份有限公司