

THIS DOCUMENT IS SUBJECT TO CHANGE WITHOUT NOTICE. IT IS CONFIDENTIAL AND A PROPERTY OF Amphenol LTW. DISCLOSURE TO THIRD PARTY HAS TO BE AUTHORIZED BY Amphenol LTW.

REV.	ECN NO.	DATE	SIGN	DESCRIPTION
C	C192023	2019/11/20	Vicky	△C X4
D	C200637	2020/05/05	Victor Hung	△D X2
E	C231241	2023/09/22	Ruru	△E X2

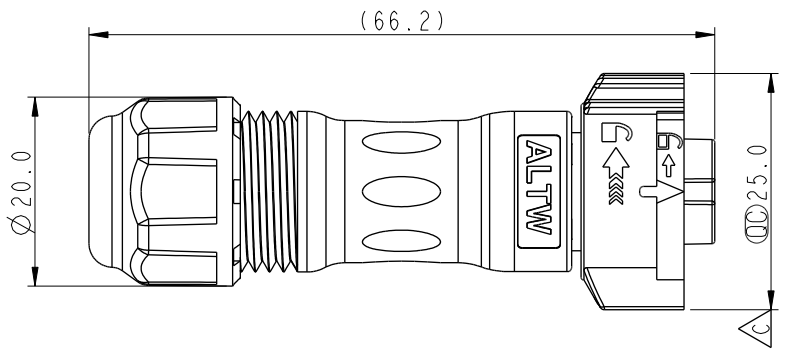
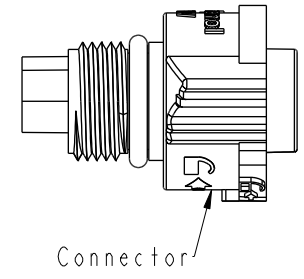
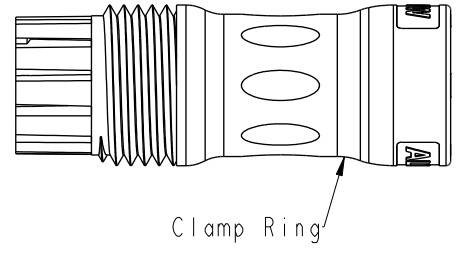
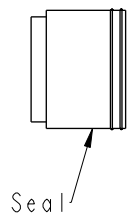
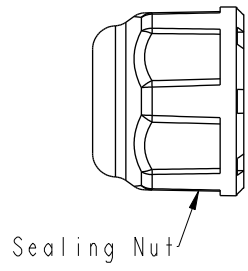

△E BD-XXBFMA-QL8XN0
 XX: No. Of Pin

- △S: With Red Color Seal 1, Cable OD 5.0~6.0mm.
- △M: With Yellow Color Seal 2, Cable OD 6.0~8.0mm.
- △L: With Blue Color Seal 3, Cable OD 8.0~10.0mm.
- △A: With Seal 1 & Seal 2 & Seal 3.

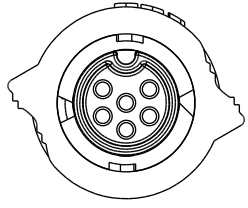
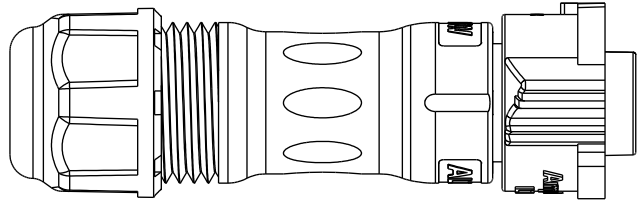

Pin Assignments Front View	2 Pin	3 Pin	4 Pin	5 Pin	6 Pin

- △C Note:
- * ∅ Important Dimension
 - * Waterproof Rate: IP68, mated 1m/24h
 - * Housing: Thermoplastic, Black
 - * Clamp Ring: Thermoplastic, Black
 - * Sealing Nut: Thermoplastic, Black
 - * Seals: Rubber
 - △E * One set unassembled in one pe bag

UNIT:mm TOLERANCE ±0.5mm		TITLE XLOK, B-5A, CABLE W/O SR F, M, FI CRIMP, XLOK		<h1>Amphenol LTW</h1> <p>安費諾亮泰企業股份有限公司</p>	ITEM NO	DRAWN BY Victor Hung	DATE 2020/05/11		
		SCALE 1:1	SIZE A4		SHEET 1	OF 1	DWG NO BD-XXBFMA-QL8XN0	CHECKED BY Aric Ko	DATE 2020/05/11
		REV. E	WC-REV. .0		∅∅: Inspection item		CUSTOMER ALTW	APPROVED BY Max Yang	DATE 2020/05/11