

THIS DOCUMENT IS SUBJECT TO CHANGE WITHOUT NOTICE. IT IS CONFIDENTIAL AND A PROPERTY OF AMPHENOL LTW. DISCLOSURE TO THIRD PARTY HAS TO BE AUTHORIZED BY AMPHENOL LTW.

REV.	ECN NO.	DATE	SIGN	DESCRIPTION
B	E191899	2019/11/12	Ruru	$\triangle B$ X4
C	C231238	2023/09/20	Vicky	$\triangle C$ X1

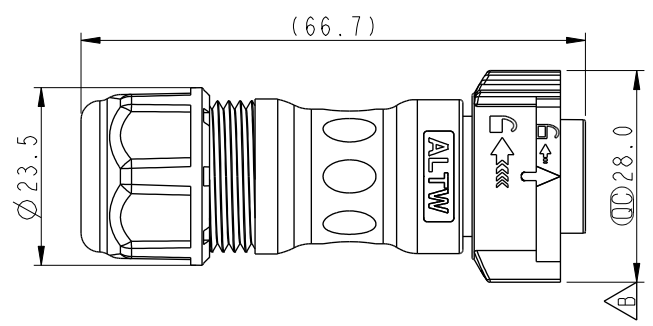
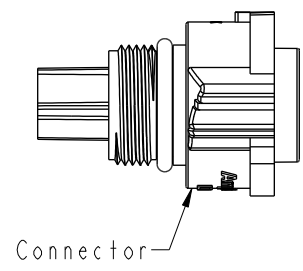
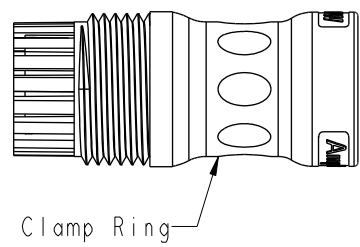
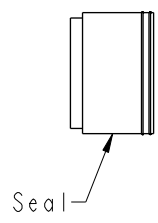
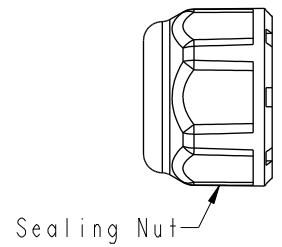

CC-XXBFMA-QL8XNP
 02-2 Pin
 03-3 Pin

S: With Red Color Seal 1, Cable OD 6.0~8.0mm.
 M: With Yellow Color Seal 2, Cable OD 8.0~10.0mm.
 L: With Blue Color Seal 3, Cable OD 10.0~12.0mm.
 A: With Seal 1 & Seal 2 & Seal 3.

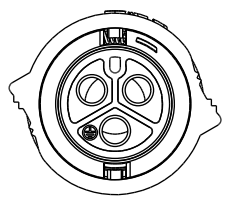
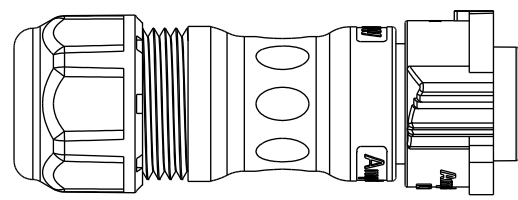

- $\triangle B$ Note:
- * \varnothing Important Dimension
 - * Waterproof Rate: IP68, Mated
IP68 : 1M Depth Of Water In 24hours
 - * Housing: Thermoplastic, Black
 - * Clamp Ring: Thermoplastic, Black
 - * Sealing Nut: Thermoplastic, Black
 - * Seals: Rubber
- $\triangle C$ * One set unassembled in one pe bag

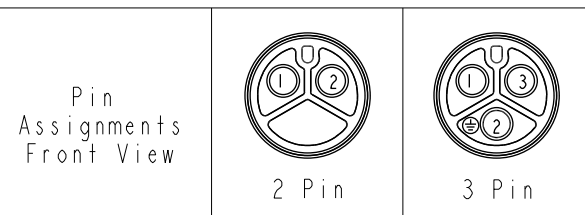

UNIT:mm	\varnothing	TITLE	XLOK, C-20A, CABLE W/O SR, F, M, FI CRIMP, XLOK $\triangle B$	
TOLERANCE	± 0.5 mm	SCALE	1:1	SIZE A4
		REV.	C	WC-REV. A.1
			\varnothing : Inspection item	

Amphenol LTW
 安費諾亮泰企業股份有限公司

ITEM NO	DRAWN BY	DATE
	Ruru	2019-11-12
DWG NO	CHECKED BY	DATE
CC-XXBFMA-QL8XNP $\triangle B$	Rita	2019-11-12
CUSTOMER	APPROVED BY	DATE
ALTW	Max	2019-11-12