

THIS DOCUMENT IS SUBJECT TO CHANGE WITHOUT NOTICE. IT IS CONFIDENTIAL AND A PROPERTY OF Amphenol LTW. DISCLOSURE TO THIRD PARTY HAS TO BE AUTHORIZED BY Amphenol LTW.

REV.	ECN NO.	DATE	SIGN	DESCRIPTION
C	C220112	2022/01/17	Ruru	△C XI
D	C220230	2022/02/16	Ruru	△D XI
E	C231239	2023/09/21	Vicky	△E XI

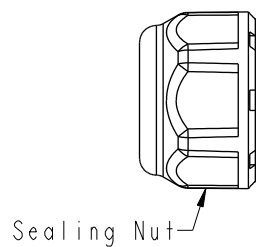

Sealing Nut

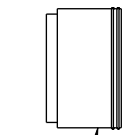

Seal

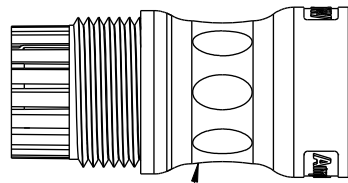

Clamp Ring

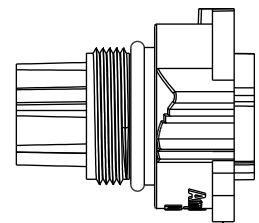

Connector

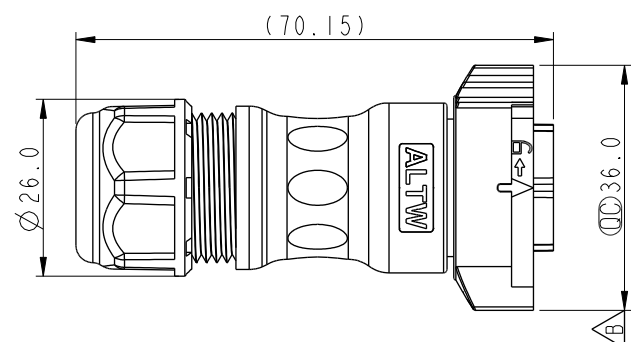

DC-XXBFFA-QL8XPP
 02-2 Pin
 03-3 Pin
 05-5 Pin

△C △D
 S: With Red Color Seal 1, Cable OD 8.0~10.0mm.
 M: With Yellow Color Seal 2, Cable OD 10.0~12.0mm.
 L: With Blue Color Seal 3, Cable OD 12.0~14.0mm.
 A: With Seal 1 & Seal 2 & Seal 3.

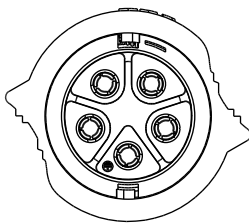
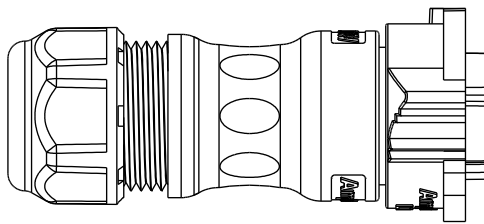

△B Note:
 * ∅ Important Dimension
 * Waterproof Rate: IP68, Mated
 IP68 : IM Depth Of Water In 24hours
 * Housing: Thermoplastic, Black
 * Pin: Copper Alloy, Gold Plated
 * Clamp Ring: Thermoplastic, Black
 * Sealing Nut: Thermoplastic, Black
 * Seals: Rubber
 △E * One set unassembled in one pe bag

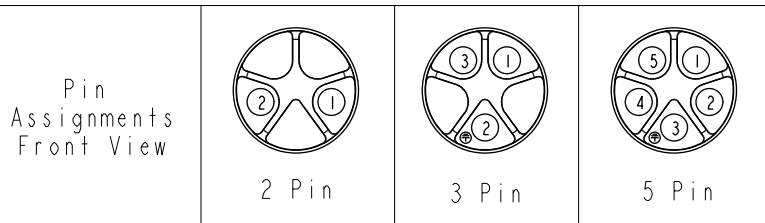

A	UNIT:mm		TITLE	XLOK, D-20A, CABLE W/O SR F, F, FI CRIMP, XLOK △B		ITEM NO	DRAWN BY	DATE
	TOLERANCE	±0.5 mm	SCALE			1:1	SIZE	A4
	REV.	E	WC-REV.	A.1	QC	Inspection item	DC-XXBFFA-QL8XPP △B	Rita
<p style="text-align: center;">Amphenol LTW 安費諾亮泰企業股份有限公司</p>						CUSTOMER	APPROVED BY	DATE
						ALTW	Max	2019-11-15