

THIS DOCUMENT IS SUBJECT TO CHANGE WITHOUT NOTICE. IT IS CONFIDENTIAL AND A PROPERTY OF Amphenol LTW. DISCLOSURE TO THIRD PARTY HAS TO BE AUTHORIZED BY Amphenol LTW.

REV.	ECN NO.	DATE	SIGN	DESCRIPTION
C	C220112	2022/01/18	Ruru	△C XI
D	C220230	2022/02/16	Ruru	△D XI
E	C231239	2023/09/21	Vicky	△E XI

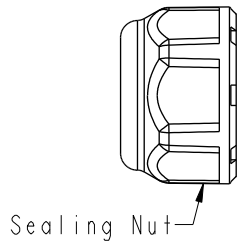

Sealing Nut

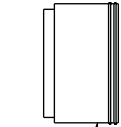

Seal

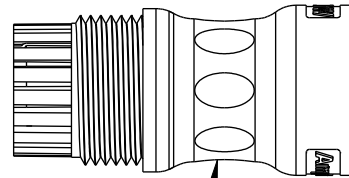

Clamp Ring

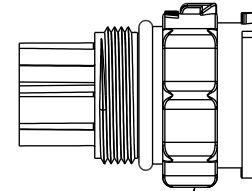

Connector

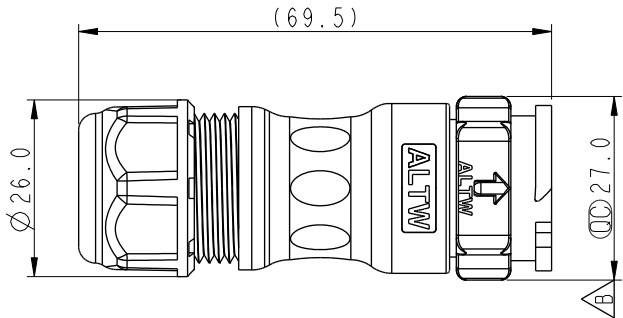

DC-XXBMMA-QL8XNP
 02-2 Pin
 03-3 Pin
 05-5 Pin

△C △D
 S: With Red Color Seal 1, Cable OD 8.0~10.0mm.
 M: With Yellow Color Seal 2, Cable OD 10.1~12.0mm.
 L: With Blue Color Seal 3, Cable OD 12.1~14.0mm.
 A: With Seal 1 & Seal 2 & Seal 3.

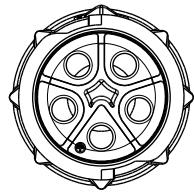
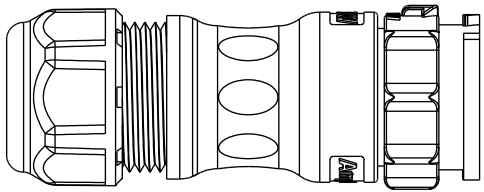

- △B Note:
- * ∅ Important Dimension
 - * Waterproof Rate: IP68, Mated
IP68 : 1M Depth Of Water In 24hours
 - * Housing: Thermoplastic, Black
 - * Clamp Ring: Thermoplastic, Black
 - * Sealing Nut: Thermoplastic, Black
 - * Seals: Rubber
- △E * One set unassembled in one pe bag

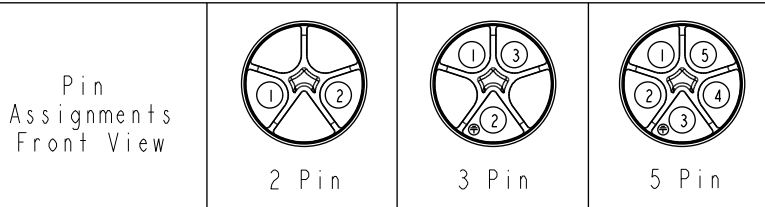

UNIT:mm		TITLE	XLOK, D-20A, CABLE W/O SR M, M, FI CRIMP, XLOK △B	
TOLERANCE	±0.5 mm	SCALE	1:1	SHEET 1 OF 1
		REV.	E	WC-REV. .0
				∅: Inspection item

Amphenol LTW
 安費諾亮泰企業股份有限公司

ITEM NO	DWG NO	CUSTOMER	DRAWN BY	CHECKED BY	APPROVED BY	DATE
	DC-XXBMMA-QL8XNP △B	ALTW	Ruru	Rita	Max	2019-11-19