

THIS DOCUMENT IS SUBJECT TO CHANGE WITHOUT NOTICE. IT IS CONFIDENTIAL AND A PROPERTY OF Amphenol LTW. DISCLOSURE TO THIRD PARTY HAS TO BE AUTHORIZED BY Amphenol LTW.

REV.	ECN NO.	DATE	SIGN	DESCRIPTION
C	C220112	2022/01/18	Ruru	△C XI
D	C220230	2022/02/16	Ruru	△D XI
E	C231239	2023/09/21	Vicky	△E XI

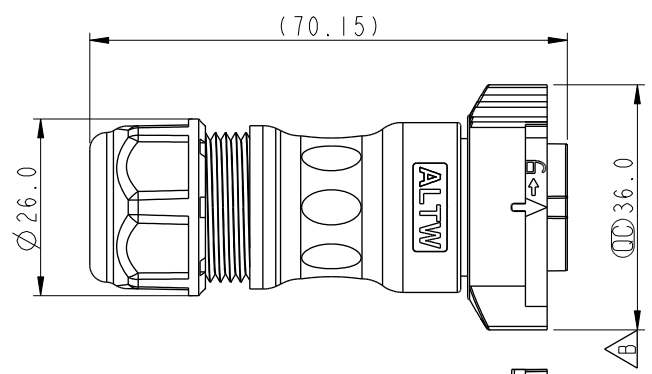
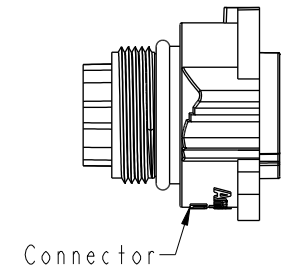
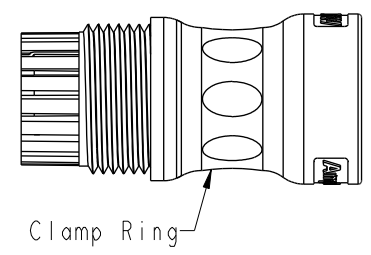
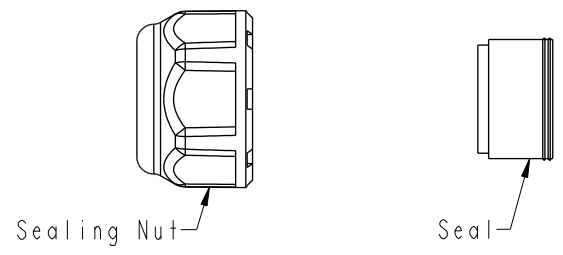

DD-XXBFFA-QL8XN0

14-14 Pin
18-18 Pin

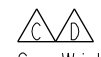

S: With Red Color Seal 1, Cable OD 8.0~10.0mm.
M: With Yellow Color Seal 2, Cable OD 10.0~12.0mm.
L: With Blue Color Seal 3, Cable OD 12.0~14.0mm.
A: With Seal 1 & Seal 2 & Seal 3.

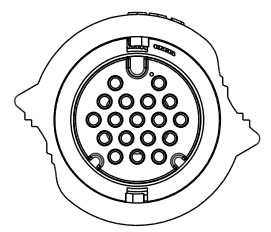
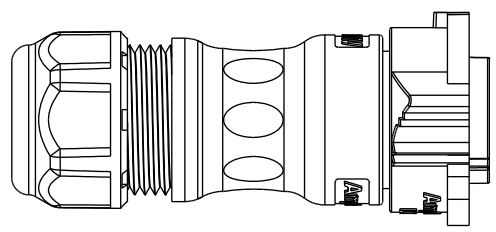

- △B Note:
- * ∅ Important Dimension
 - * Waterproof Rate: IP68, Mated
IP68 : 1M Depth Of Water In 24hours
 - * Housing: Thermoplastic, Black
 - * Clamp Ring: Thermoplastic, Black
 - * Sealing Nut: Thermoplastic, Black
 - * Seals: Rubber
- △E * One set unassembled in one pe bag

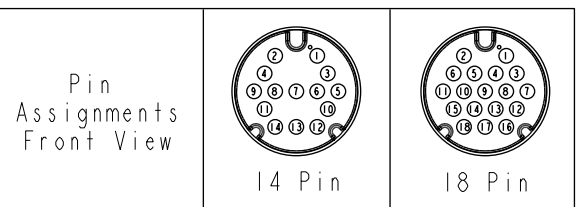

UNIT:mm		TITLE	XLOK, D-5A, CABLE W/O SR F, F, FI CRIMP, XLOK △B	
TOLERANCE	±0.5 mm	SCALE	1:1	SIZE A4
		REV.	E	WC-REV. .0
				∅∅: Inspection item

Amphenol LTW
安費諾亮泰企業股份有限公司

ITEM NO	DD-XXBFFA-QL8XN0 △B	DRAWN BY	Ruru	DATE	2019-11-19
DWG NO	DD-XXBFFA-QL8XN0 △B	CHECKED BY	Rita	DATE	2019-11-19
CUSTOMER	ALTW	APPROVED BY	Max	DATE	2019-11-19