

THIS DOCUMENT IS SUBJECT TO CHANGE WITHOUT NOTICE. IT IS CONFIDENTIAL AND A PROPERTY OF Amphenol LTW. DISCLOSURE TO THIRD PARTY HAS TO BE AUTHORIZED BY Amphenol LTW.

REV.	ECN NO.	DATE	SIGN	DESCRIPTION
F	C210309	2021/02/23	Ruru	X3
G	C221973	2022/12/21	Ruru	X1
H	C231034	2023/08/08	Ruru	X1

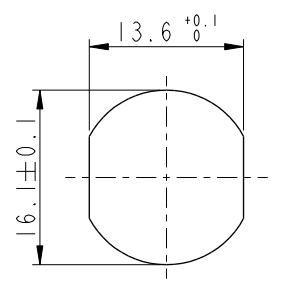

Recommended Panel Cut-Out



M12A-XXPFFP-SF8002

XX: No. Of Pin

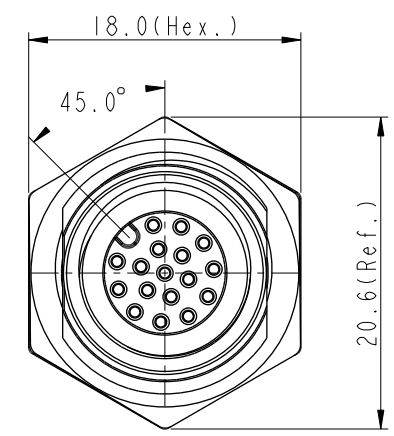
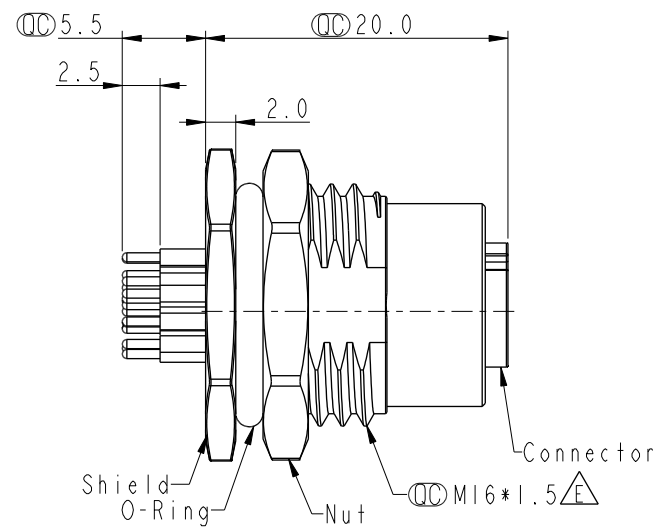
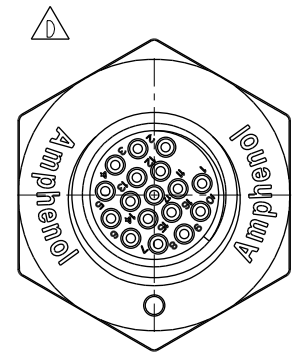

- Note:
- \* RoHS Compliant
  - \* Important dimension
  - \* Waterproof rate: IP68, unmated 1m/24h  
 IP69K, mated
  - \* Connector
    - Housing: Thermoplastic, Black
    - Pin: Copper alloy, Gold plated
    - O-Ring: Rubber, Green
  - \* Shield: Metal
  - \* Nut: Metal
  - \* O-Ring: Rubber, Black
  - \* For panel thickness max: 4.5mm
  - \* Nut is packed separately in pe bag

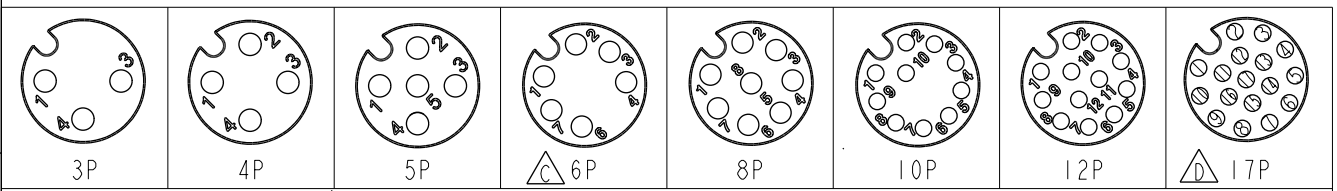





Pin Assignment Front View

UNIT: mm		TITLE N SEN, M12 A, SCREW RECEPTACLE, F, F, PCB S
TOLERANCE .X ±0.25 .XX ±0.1 .XXX ±0.05 ANGLES ±1°	SCALE 2:1	SIZE A4
	REV. H	SHEET 1 OF 2
	WC-REV. A.5	: Inspection item

**Amphenol LTW**  
安費諾亮泰企業股份有限公司

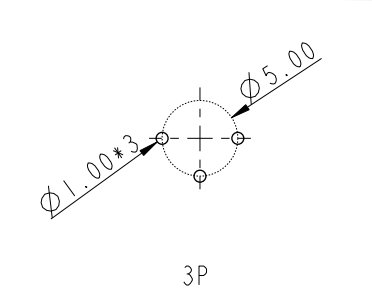
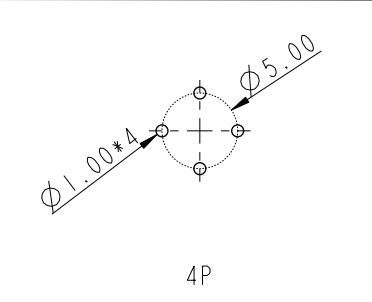
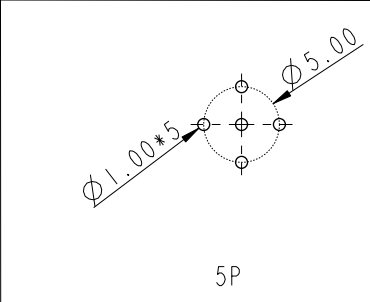
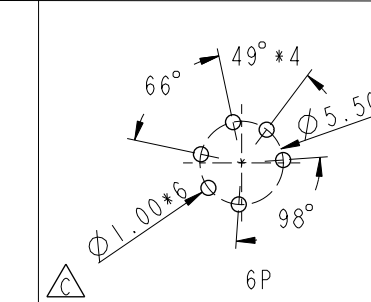
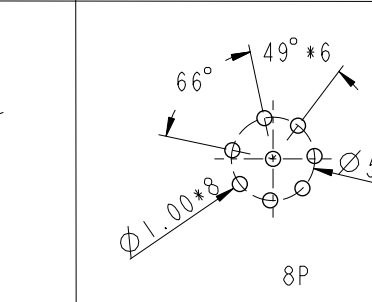
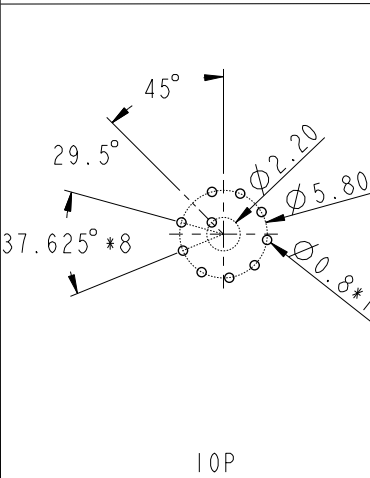
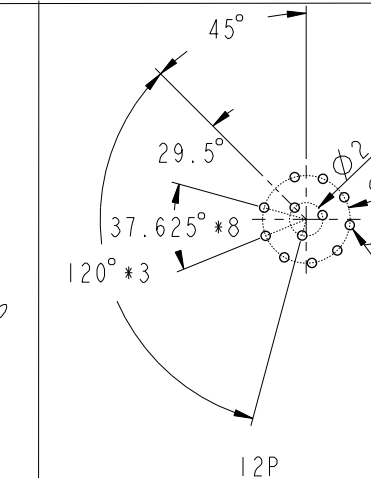
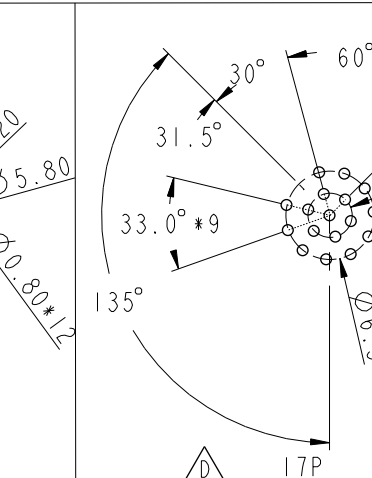
ITEM NO	DRAWN BY Yulong_wang	DATE 2016-08-08
DWG NO M12A-XXPFFP-SF8002	CHECKED BY Jinhai	DATE 2016-08-08
CUSTOMER ALTW	APPROVED BY Jerry	DATE 2016-08-08

THIS DOCUMENT IS SUBJECT TO CHANGE WITHOUT NOTICE. IT IS CONFIDENTIAL AND A PROPERTY OF Amphenol LTW. DISCLOSURE TO THIRD PARTY HAS TO BE AUTHORIZED BY Amphenol LTW.

F									
E									
D	PCB Layout								
C	 <p style="text-align: center;">3P</p>	 <p style="text-align: center;">4P</p>	 <p style="text-align: center;">5P</p>	 <p style="text-align: center;">6P</p>	 <p style="text-align: center;">8P</p>	 <p style="text-align: center;">10P</p>	 <p style="text-align: center;">12P</p>	 <p style="text-align: center;">17P</p>	
B									
A	UNIT: mm  		TITLE N SEN, M12 A, SCREW RECEPTACLE, F, F, PCB S 			ITEM NO M12A-XXPFFP-SF8002		DRAWN BY Yulong_wang	DATE 2016-08-08
TOLERANCE .X ±0.25 .XX ±0.1 .XXX ±0.05 ANGLES ±1°		SCALE 2:1	SIZE A4	SHEET 2 OF 2		DWG NO  M12A-XXPFFP-SF8002		CHECKED BY Jinhai	DATE 2016-08-08
		REV. H	WC-REV. A.4	(CC): Inspection item		CUSTOMER ALTW		APPROVED BY Jerry	DATE 2016-08-08
	2	3	4	5	6	7	8	W10814-03-01A2	

**Amphenol LTW**  
安費諾亮泰企業股份有限公司