

THIS DOCUMENT IS SUBJECT TO CHANGE WITHOUT NOTICE. IT IS CONFIDENTIAL AND A PROPERTY OF Amphenol LTW. DISCLOSURE TO THIRD PARTY HAS TO BE AUTHORIZED BY Amphenol LTW.

REV.	ECN NO.	DATE	SIGN	DESCRIPTION
G	C210309	2021/02/24	Ruru	$\triangle G$ X3
H	C221973	2022/12/21	Ruru	$\triangle H$ XI
I	C231034	2023/08/10	Ruru	$\triangle I$ XI

$\triangle B$

$\triangle E$   
M12A-XXPMMP-SF8002

XX: No. Of Pin

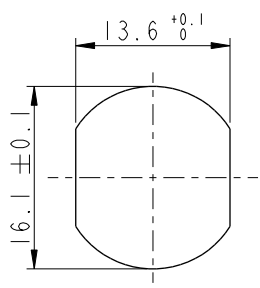

Recommended  
Panel Cut-Out

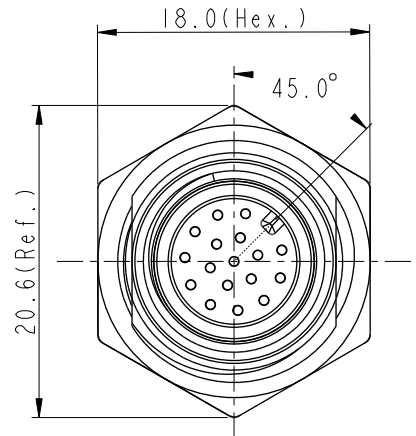
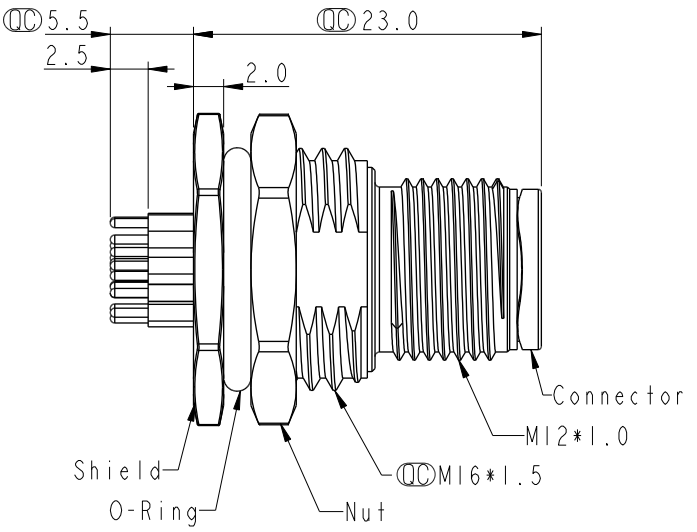
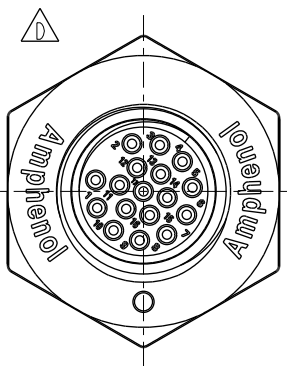

- $\triangle E \triangle G$  Note:
- \* RoHS Compliant
  - \*  $\text{CC}$  Important dimension
  - $\triangle H \triangle C$  \* Waterproof rate: IP68, unmated 1m/24h
  - $\triangle I$  IP69K, mated
  - \* Connector
  - Housing: Thermoplastic, Black
  - Pin: Copper alloy, Gold plated
  - $\triangle F$  \* Shield: Metal
  - $\triangle F$  \* Nut: Metal
  - \* O-Ring: Rubber, Black
  - \* For panel thickness max: 4.5mm
  - \* Nut is packed separately in pe bag

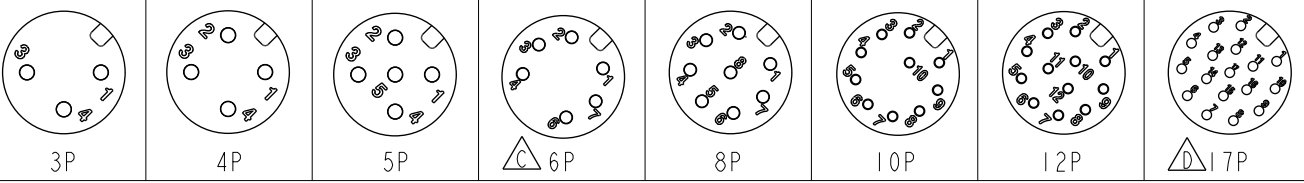





Pin Assignment Front View

UNIT: mm			TITLE N SEN, M12 A, SCREW RECEPTACLE, M, M, PCB S $\triangle G$
TOLERANCE	.X ±0.25	.XX ±0.1	SCALE 2:1
.XXX ±0.05	ANGLES ±1°		SIZE A4
			SHEET 1 OF 2
			REV. 1
			WC-REV. A.5
			$\text{CC}$ : Inspection item

**Amphenol LTW**  
安費諾亮泰企業股份有限公司

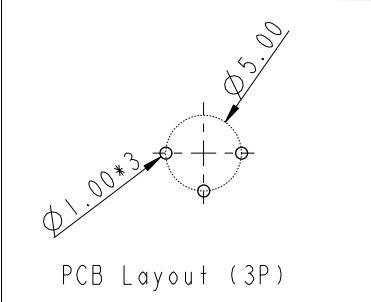
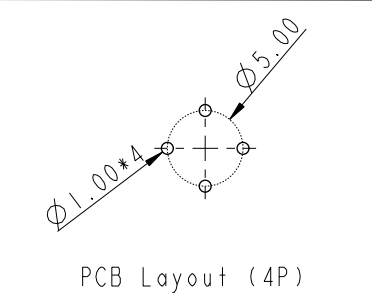
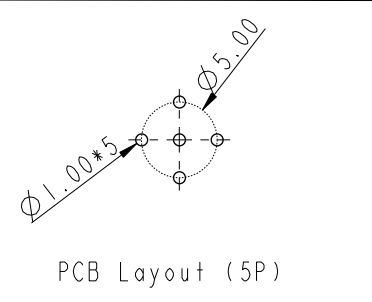
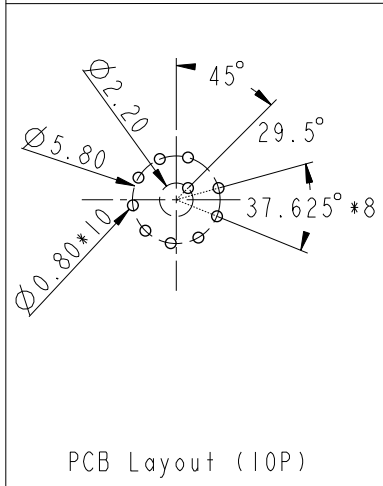
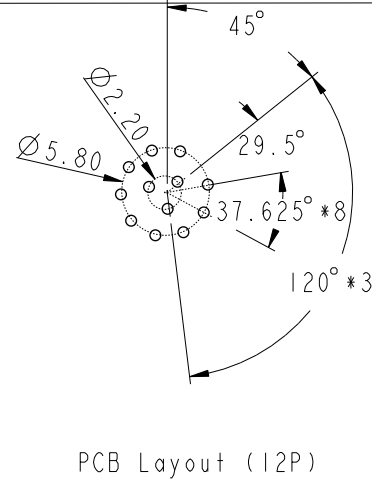
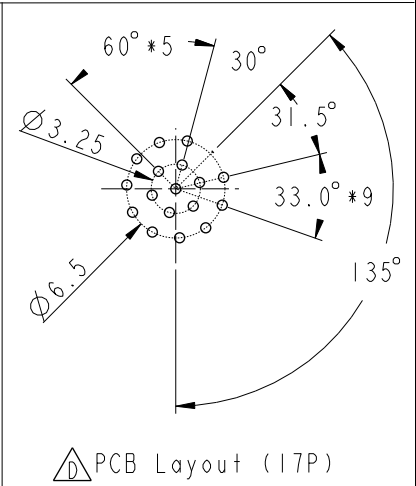
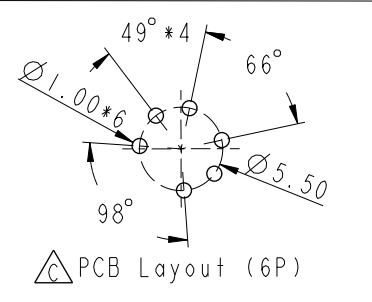
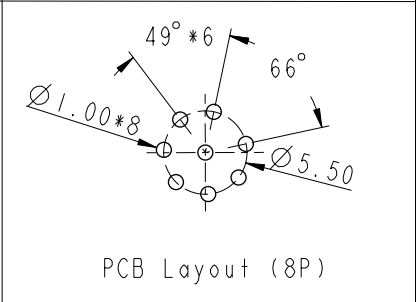
ITEM NO	DRAWN BY Yulong_wang	DATE 2016-08-08
DWG NO $\triangle E$ M12A-XXPMMP-SF8002	CHECKED BY Jinhai	DATE 2016-08-08
CUSTOMER ALTW	APPROVED BY Jerry	DATE 2016-08-08

THIS DOCUMENT IS SUBJECT TO CHANGE WITHOUT NOTICE. IT IS CONFIDENTIAL AND A PROPERTY OF Amphenol LTW. DISCLOSURE TO THIRD PARTY HAS TO BE AUTHORIZED BY Amphenol LTW.

F		2	3	4	5	6	7	8	
E									
D	PCB Layout								
C	 <p style="text-align: center;">PCB Layout (3P)</p>	 <p style="text-align: center;">PCB Layout (4P)</p>	 <p style="text-align: center;">PCB Layout (5P)</p>	 <p style="text-align: center;">PCB Layout (10P)</p>	 <p style="text-align: center;">PCB Layout (12P)</p>	 <p style="text-align: center;">PCB Layout (17P)</p>	 <p style="text-align: center;">PCB Layout (6P)</p>	 <p style="text-align: center;">PCB Layout (8P)</p>	
B									
A	UNIT: mm  	TITLE N SEN, M12 A, SCREW RECEPTACLE, M, M, PCB S 		<h1 style="margin: 0;">Amphenol LTW</h1> <h2 style="margin: 0;">安費諾亮泰企業股份有限公司</h2>		ITEM NO M12A-XXPMMP-SF8002 CUSTOMER ALTW	DRAWN BY Yulong_wang CHECKED BY Jinhai APPROVED BY Jerry	DATE 2016-08-08 DATE 2016-08-08 DATE 2016-08-08	
	TOLERANCE .X ±0.25 .XX ±0.1 .XXX ±0.05 ANGLES ±1°	SCALE 2:1	SIZE A4	SHEET 2 OF 2	WC-REV. A.4	 : Inspection item			
	2	3	4	5	6	7	8	W10814-03-001A2	