

THIS DOCUMENT IS SUBJECT TO CHANGE WITHOUT NOTICE. IT IS CONFIDENTIAL AND A PROPERTY OF Amphenol LTW. DISCLOSURE TO THIRD PARTY HAS TO BE AUTHORIZED BY Amphenol LTW.

REV.	ECN NO.	DATE	SIGN	DESCRIPTION
I	C221879	2022/12/19	Ruru	△ XI
J	C231033	2023/08/07	Ruru	△ J XI
K	C240700	2024/06/19	Ruru	△ K X2

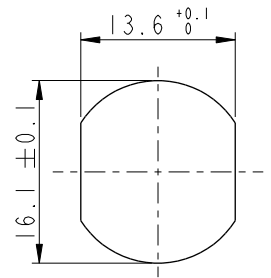
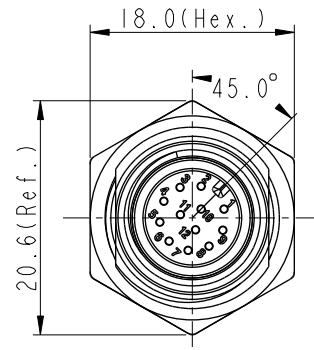
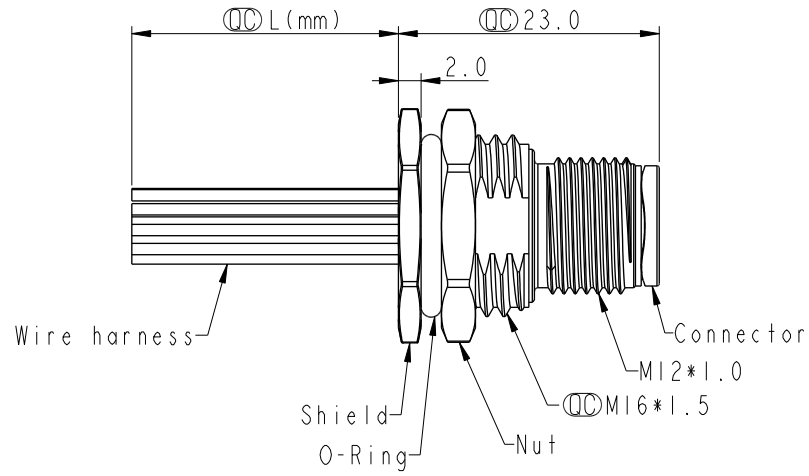
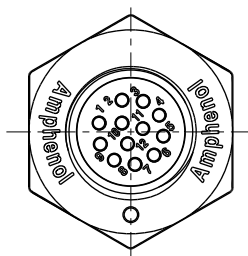

Recommended Panel Cut-Out

- Note: △ C D F G H
- \* RoHS Compliant
  - \* Ⓞ Important dimension
  - △ \* Waterproof rate: IP68, unmated 1m/24h  
△ IP69K, mated
  - \* Connector  
Housing: Thermoplastic, Black  
Pin: Copper alloy, Gold plated
  - \* Shield: Metal
  - \* Nut: Metal
  - \* O-Ring: Rubber, Black
  - \* Wire harness: UL1061
  - \* For panel thickness max: 4.5mm
  - \* O-Ring and nut are assembled on connectors
  - △ \* Wire harness tolerance: 150mm < L ≤ 300mm: ±15mm  
300mm < L ≤ 1000mm: ±20mm  
1000mm < L ≤ 1500mm: +50/-0mm

UNIT: mm	
TOLERANCE	
.X	±0.25
.XX	±0.1
.XXX	±0.05
ANGLES	±1°

TITLE N SEN, M12 A, SCREW RECEPTACLE, M, M, SOLDER △			
SCALE 1:1	SIZE A4	SHEET 1 OF 2	
REV. K	WC-REV. A.5	Ⓞ: Inspection item	

**Amphenol LTW**  
安費諾亮泰企業股份有限公司

ITEM NO. M12A-XXPMMS-SF8CXX	DRAWN BY Ruru	DATE 2024-06-19
DWG NO. M12A-XXPMMS-SF8CXX	CHECKED BY Rita	DATE 2024-06-19
CUSTOMER ALTW	APPROVED BY Fred	DATE 2024-06-19

THIS DOCUMENT IS SUBJECT TO CHANGE WITHOUT NOTICE. IT IS CONFIDENTIAL AND A PROPERTY OF Amphenol LTW. DISCLOSURE TO THIRD PARTY HAS TO BE AUTHORIZED BY Amphenol LTW.

12P	26	M12A-12PMMS-SF8CXX
10P		M12A-10PMMS-SF8CXX
8P	24	M12A-08PMMS-SF8CXX
6P		M12A-06PMMS-SF8CXX
Contacts	AWG	Item No.



  
 M12A-XXPMMS-SF8CXX

XX: No. Of Pin

  
 15:150mm  
 20:200mm  
 }  
 95:950mm  
 Cable Pitch Unit=50mm  
  
 A0:1000mm  
 }  
 A5:1500mm  
 Cable Pitch Unit=100mm  
 Wire Length (L):150~1500 mm

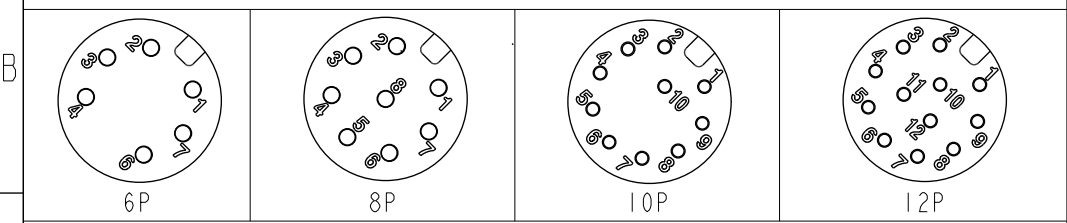
8	--	8	Red	紅	12	--	12	Red/Blue	紅/藍
7	Blue	7	Blue	藍	11	--	11	Gray/Pink	灰/粉
6	Pink	6	Pink	粉	10	Violet	10	Violet	紫
5	-	5	Gray	灰	9	Black	9	Black	黑
4	Yellow	4	Yellow	黃	8	Red	8	Red	紅
3	Green	3	Green	綠	7	Blue	7	Blue	藍
2	Brown	2	Brown	棕	6	Pink	6	Pink	粉
1	White	1	White	白	5	Gray	5	Gray	灰
Pin #	Wire	Pin #	Wire		Pin #	Wire	Pin #	Wire	



UNIT:mm			TITLE N SEN, M12 A, SCREW RECEPTACLE, M, M, SOLDER 
TOLERANCE .X ±0.25 .XX ±0.1 .XXX ±0.05 ANGLES ±1°	SCALE 1:1	SIZE A4	SHEET 2 OF 2
	REV. K	WC-REV. A.5	QC: Inspection item

**Amphenol LTW**  
 安費諾亮泰企業股份有限公司

ITEM NO	DRAWN BY Ruru	DATE 2024-06-19
DWG NO  M12A-XXPMMS-SF8CXX	CHECKED BY Rita	DATE 2024-06-19
CUSTOMER ALTW	APPROVED BY Fred	DATE 2024-06-19