

THIS DOCUMENT IS SUBJECT TO CHANGE WITHOUT NOTICE. IT IS CONFIDENTIAL AND A PROPERTY OF Amphenol LTW. DISCLOSURE TO THIRD PARTY HAS TO BE AUTHORIZED BY Amphenol LTW.

REV.	ECN NO.	DATE	SIGN	DESCRIPTION
A	-	2022-03-02	Jiahe Lin	Rev.01 To Rev.A
B	C221694	2022/11/02	Arvin Chan	*1
C	C231052	2023/08/11	Jack Liu	*1

MSAS-XXPFFR-EE0001

XX: No. Of Pin

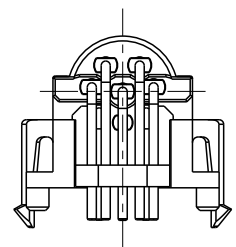
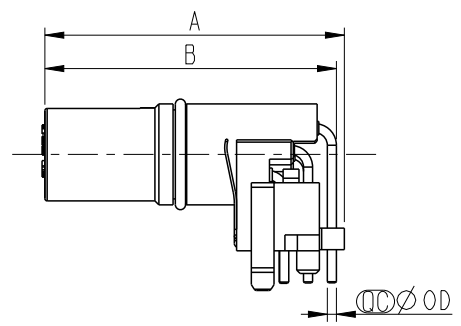
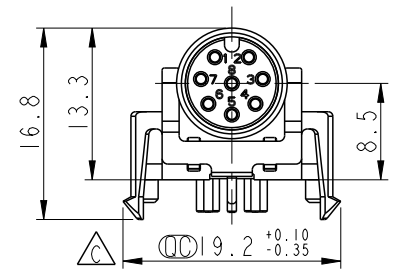
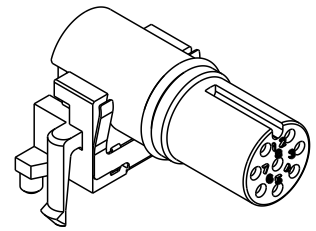
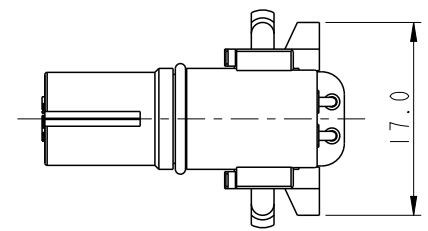

MSAS-03PFFR-EE0001	26.6	25.5	1.0
MSAS-04PFFR-EE0001	26.6	25.5	1.0
MSAS-05PFFR-EE0001	26.6	25.5	1.0
MSAS-08PFFR-EE0001	26.4	25.7	0.8
Item No.	A	B	OD

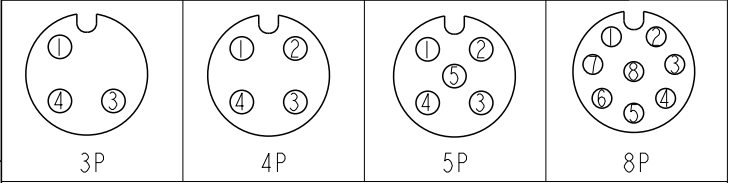

Pin Assignment Front View

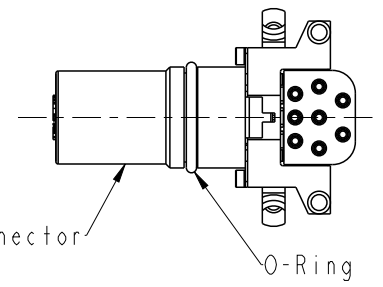

Note:

- * RoHS Compliant
- * Important dimension
- * Waterproof rate: Non-Waterproof
- * Connector
- Housing: Thermoplastic, Black
- Pin: Copper alloy, Gold plated
- O-Ring: Rubber, Gray
- * For pcb thickness max: 1.6mm

UNIT:mm		TITLE N SEN, M12 A -SHLD, RECEPTACLE, F, F, PCB R	
TOLERANCE	.X ±0.25 .XX ±0.1 .XXX ±0.05 ANGLES ±1°	SCALE 3:2	SIZE A4
		SHEET 1	OF 2
REV. C	WC-REV. A.3	Inspection item	

Amphenol LTW

安費諾亮泰企業股份有限公司

ITEM NO	DRAWN BY Jiahe Lin	DATE 2022-03-02
DWG NO MSAS-XXPFFR-EE0001	CHECKED BY Allen Pan	DATE 2022-03-02
CUSTOMER ALTW	APPROVED BY Fred Lee	DATE 2022-03-02

THIS DOCUMENT IS SUBJECT TO CHANGE WITHOUT NOTICE. IT IS CONFIDENTIAL AND A PROPERTY OF Amphenol LTW. DISCLOSURE TO THIRD PARTY HAS TO BE AUTHORIZED BY Amphenol LTW.

PCB Layout

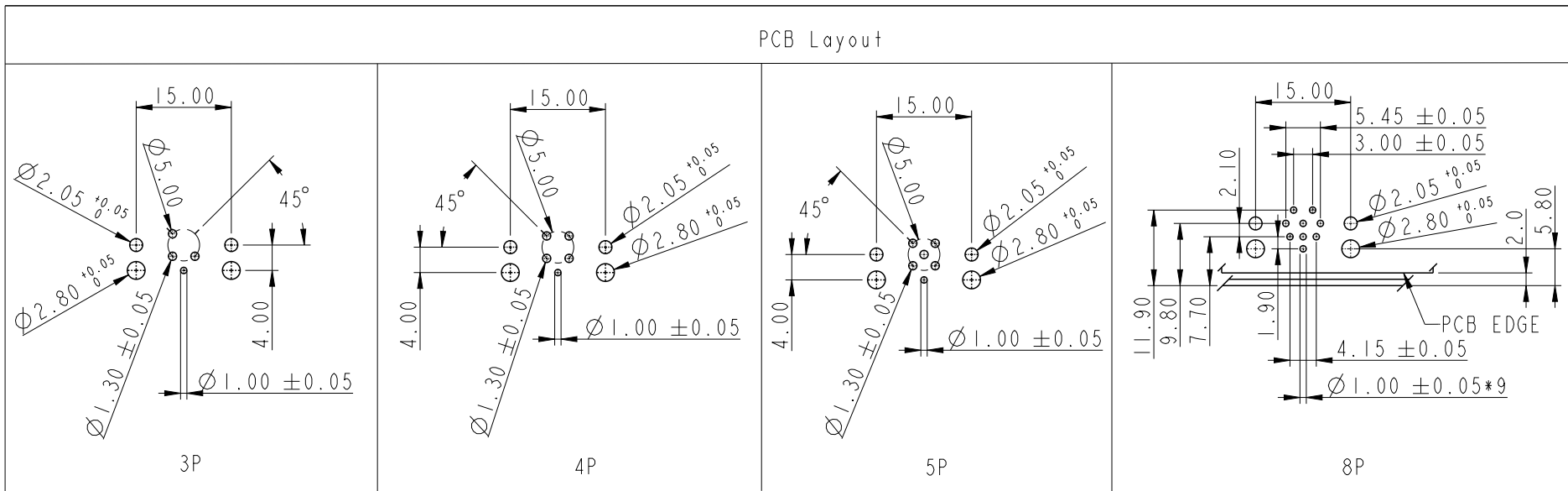

UNIT: mm		
TOLERANCE	.X	±0.25
	.XX	±0.1
	.XXX	±0.05
ANGLES		±1°

TITLE N SEN, M12 A -SHLD, RECEPTACLE, F, F, PCB R		
SCALE 3:2	SIZE A4	SHEET 2 OF 2
REV. C	WC-REV. A.3	Inspection item

Amphenol LTW
安費諾亮泰企業股份有限公司

ITEM NO	DRAWN BY Jiahe Lin	DATE 2022-03-02
DWG NO MSAS-XXPFFR-EE0001	CHECKED BY Allen Pan	DATE 2022-03-02
CUSTOMER ALTW	APPROVED BY Fred Lee	DATE 2022-03-02

DATE 2022-03-02
DATE 2022-03-02
DATE 2022-03-02