

THIS DOCUMENT IS SUBJECT TO CHANGE WITHOUT NOTICE. IT IS CONFIDENTIAL AND A PROPERTY OF Amphenol LTW. DISCLOSURE TO THIRD PARTY HAS TO BE AUTHORIZED BY Amphenol LTW.

REV.	ECN NO.	DATE	SIGN	DESCRIPTION
H	C221973	2022/12/26	Ruru	$\triangle H$ XI
I	C231034	2023/08/09	Ruru	$\triangle I$ XI
J	C240124	2024/02/27	Lavy	$\triangle J$ XI

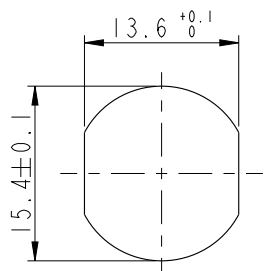

Recommended Panel Cut-Out

$\triangle B$

$\triangle E$

MSAS-XXPMMP-SF8001

XX: No. Of Pin

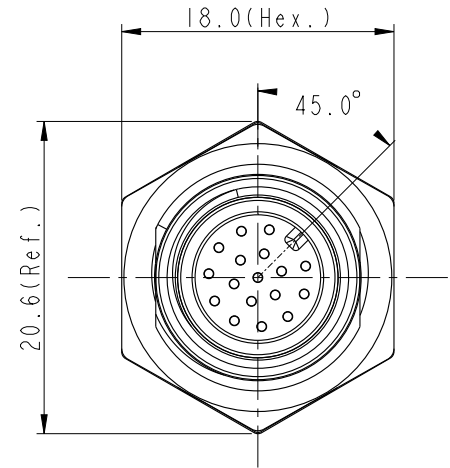
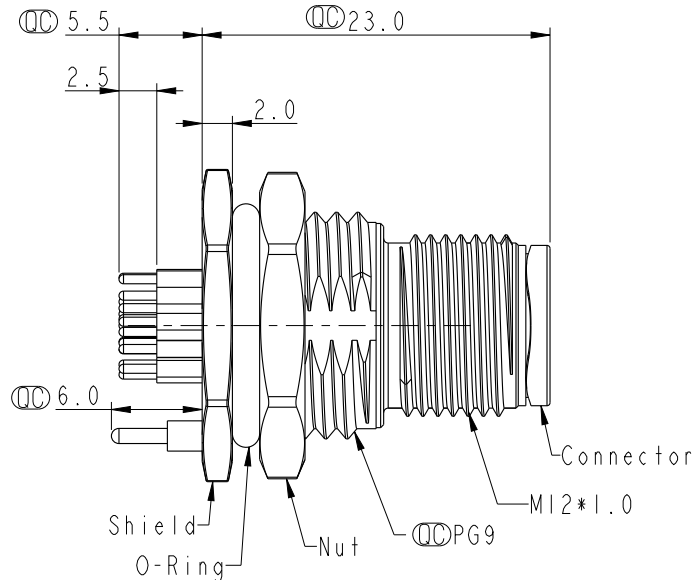
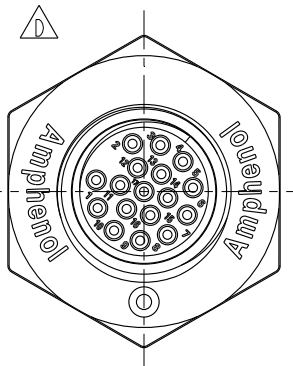



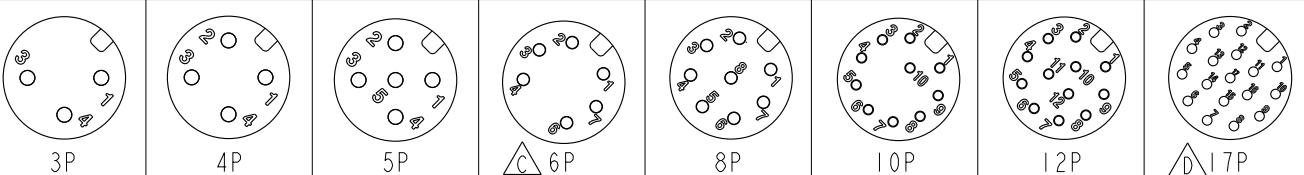

- $\triangle E \triangle G$ Note:
- * RoHS Compliant
 - * \varnothing Important dimension
 - $\triangle H \triangle C$ * Waterproof rate: IP68, unmated 1m/24h
 - $\triangle I$ IP69K, mated
 - * Connector
 - Housing: Thermoplastic, Black
 - Pin: Copper alloy, Gold plated
 - Shield: Metal
 - $\triangle E$ * Nut: Metal
 - $\triangle F$ * O-Ring: Rubber, Black
 - * For panel thickness max: 4.5mm
 - * Nut is packed separately in pe bag

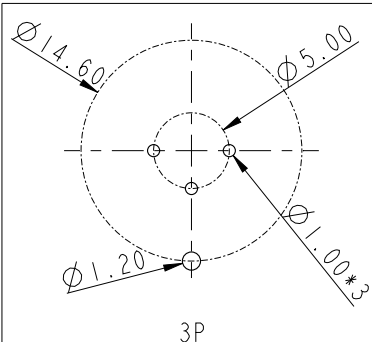
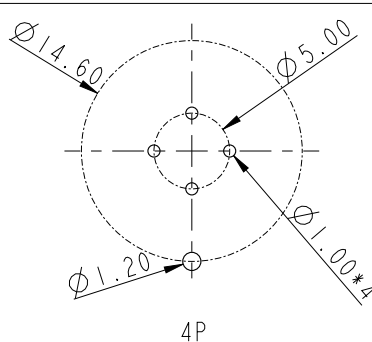
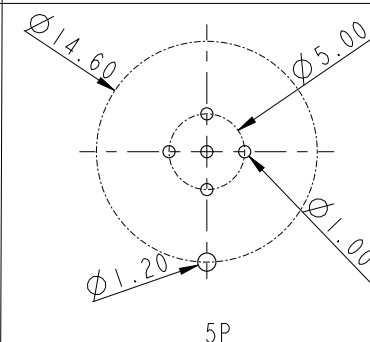
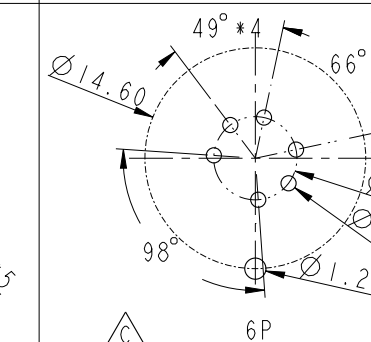
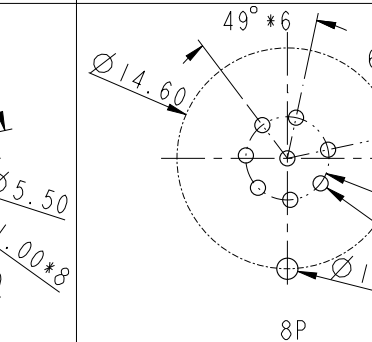
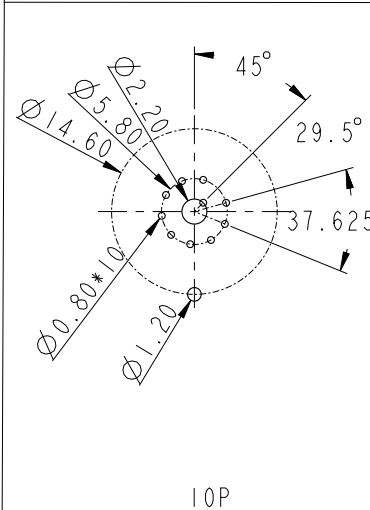
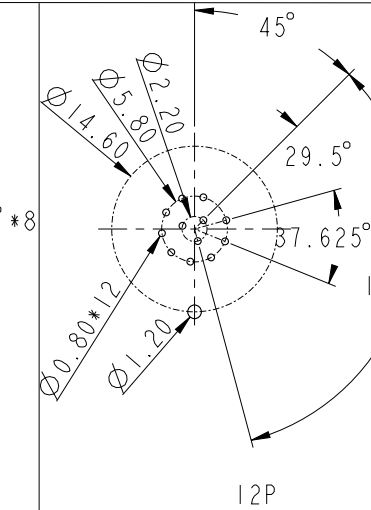
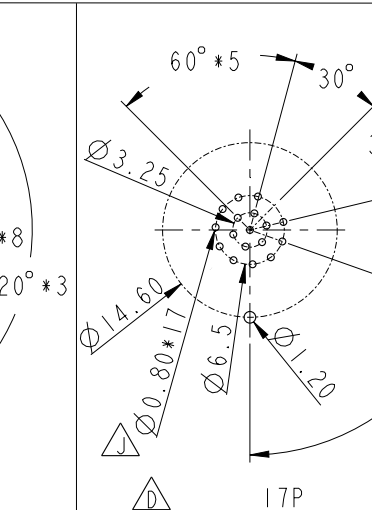

Pin Assignment Front View

UNIT: mm		TITLE N SEN, M12 A -SHLD, SCREW RECEPTACLE, M, M, PCB S $\triangle G$		Amphenol LTW 安費諾亮泰企業股份有限公司	ITEM NO	DRAWN BY Lavy	DATE 2024-02-27
		TOLERANCE .X ±0.25 .XX ±0.1 .XXX ±0.05 ANGLES ±1°	SCALE 2:1		SIZE A4	SHEET 1 OF 2	DWG NO $\triangle E$ MSAS-XXPMMP-SF8001
		REV. J	WC-REV. A.5	\varnothing : Inspection item	CUSTOMER ALTW	APPROVED BY Fred	DATE 2024-02-27

THIS DOCUMENT IS SUBJECT TO CHANGE WITHOUT NOTICE. IT IS CONFIDENTIAL AND A PROPERTY OF Amphenol LTW. DISCLOSURE TO THIRD PARTY HAS TO BE AUTHORIZED BY Amphenol LTW.

F		2	3	4	5	6	7	8				
E	PCB Layout											
D	 <p style="text-align: center;">3P</p>		 <p style="text-align: center;">4P</p>		 <p style="text-align: center;">5P</p>		 <p style="text-align: center;">6P</p>		 <p style="text-align: center;">8P</p>			
C	 <p style="text-align: center;">10P</p>				 <p style="text-align: center;">12P</p>			 <p style="text-align: center;">17P</p>				
B												
A	UNIT: mm  		TITLE N SEN, M12 A -SHLD, SCREW RECEPTACLE, M, M, PCB S 			ITEM NO DWG NO MSAS-XXPMMP-SF8001 CUSTOMER ALTW		DRAWN BY Lavy CHECKED BY Jerry APPROVED BY Fred		DATE 2024-02-27 DATE 2024-02-27 DATE 2024-02-27		
TOLERANCE .X ±0.25 .XX ±0.1 .XXX ±0.05 ANGLES ±1°		SCALE 2:1	SIZE A4	SHEET 2 OF 2		REV. J		WC-REV. A.4	(CC): Inspection item		W10814-03-001A2	

Amphenol LTW

安費諾亮泰企業股份有限公司