

THIS DOCUMENT IS SUBJECT TO CHANGE WITHOUT NOTICE. IT IS CONFIDENTIAL AND A PROPERTY OF Amphenol LTW. DISCLOSURE TO THIRD PARTY HAS TO BE AUTHORIZED BY Amphenol LTW.

REV.	ECN NO.	DATE	SIGN	DESCRIPTION
B	C230419	2023/03/29	Vicky	△B X5
C	C231210	2023/09/15	Vicky	△C XI

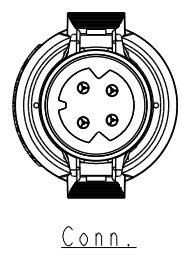
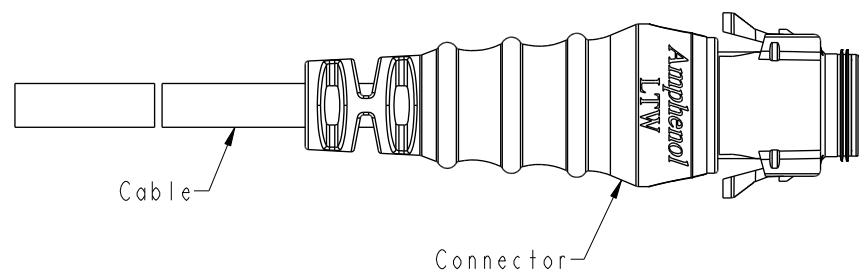
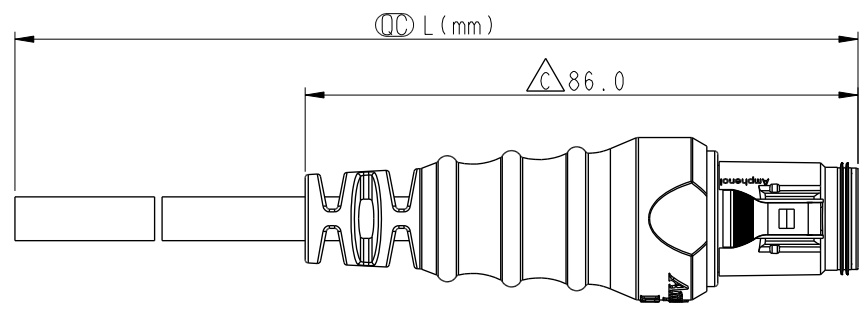

△B Note:

- * RoHS Compliant
- * (C) Important dimension
- * Waterproof rate: IP68, mated 1m/24h
- * Connector
 - Housing: Thermoplastic, Black
 - Pin: Copper alloy, Gold plated
 - O-Ring: Rubber, Gray
 - Gasket: Rubber, Gray
 - Outer mold: Thermoplastic, Black
- * Cable: UL21388, PVC Jacket, Black
- * Cable length tolerance:
 - 1M < L ≤ 3M: +100/-0 mm
 - 3M < L ≤ 5M: +150/-0 mm
 - 5M < L ≤ 10M: ±100 mm
 - 10M < L ≤ 20M: ±200 mm
 - 20M < L ≤ 30M: ±300 mm
 - 30M < L ≤ 99M: ±500 mm

A	UNIT: mm			TITLE	△B				
	TOLERANCE	±0.5mm		RBL, C-10A, CABLE W/SR M, M, MOLDING, RBL					
	SCALE	1:1	SIZE	A4		SHEET	1	OF	2
	REV.	C	WC-REV.	A.5		(C): Inspection item			

Amphenol LTW
安費諾亮泰企業股份有限公司

ITEM NO.	DRAWN BY	DATE
	Peng	2019-03-30
DWG NO.	CHECKED BY	DATE
CB-XXAMMM-RL8DXX	Jerry	2019-03-30
CUSTOMER	APPROVED BY	DATE
ALTW	Max	2019-03-30

THIS DOCUMENT IS SUBJECT TO CHANGE WITHOUT NOTICE. IT IS CONFIDENTIAL AND A PROPERTY OF AMPHENOL LTW. DISCLOSURE TO THIRD PARTY HAS TO BE AUTHORIZED BY AMPHENOL LTW.

4P		6.8	16	CB-04AMMM-RL8DXX
3P		6.5		CB-03AMMM-RL8DXX
2P		6.0		CB-02AMMM-RL8DXX
Contacts	Cable OD	AWG	Item No.	

△ B CB-XXAMMM-RL8DXX

XX: No. Of Pin

XX: 01~99Meters
 01: 01Meter
 02: 02Meters
 :
 99: 99Meters

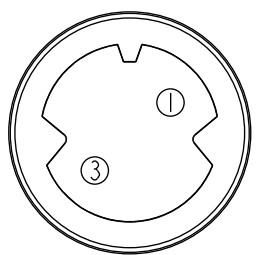
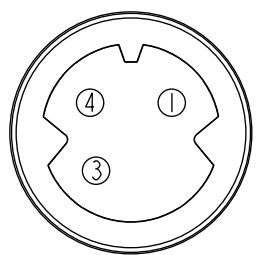
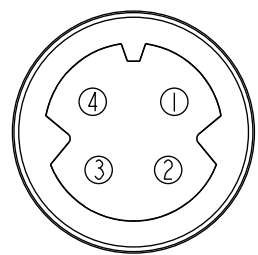
Pin Out	4	--	4	Brown	棕	4	Brown	棕	
	3	Red	紅	3	Red	紅	3	Red	紅
	2	--	2	--		2	Orange	橘	
	1	Black	黑	1	Black	黑	1	Black	黑
Conn.									
	2P		3P		4P				

Pin Assignments Front View

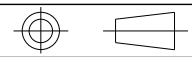
UNIT: mm		TITLE	RBL, C-10A, CABLE W/SR M, M, MOLDING, RBL	△ B					
TOLERANCE	±0.5mm	SCALE	1:1	SIZE	A4	SHEET	2	OF	2
		REV.	C	WC-REV.	A.5	QC: Inspection item			

Amphenol LTW
 安費諾亮泰企業股份有限公司

ITEM NO	DRAWN BY	DATE
DWG NO	CHECKED BY	DATE
CUSTOMER	APPROVED BY	DATE
	Peng	2019-03-30
CB-XXAMMM-RL8DXX	Jerry	2019-03-30
ALTW	Max	2019-03-30