

THIS DOCUMENT IS SUBJECT TO CHANGE WITHOUT NOTICE. IT IS CONFIDENTIAL AND A PROPERTY OF Amphenol LTW. DISCLOSURE TO THIRD PARTY HAS TO BE AUTHORIZED BY Amphenol LTW.

REV.	ECN NO.	DATE	SIGN	DESCRIPTION
B	C230419	2023/03/29	Vicky	△B X5
C	C231210	2023/09/15	Vicky	△C X1

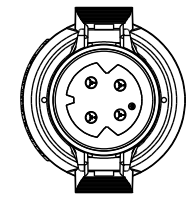
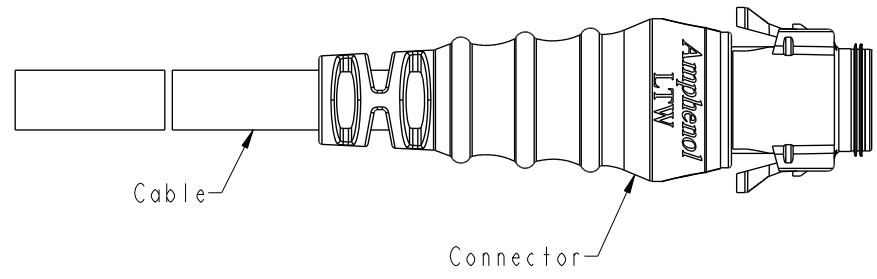
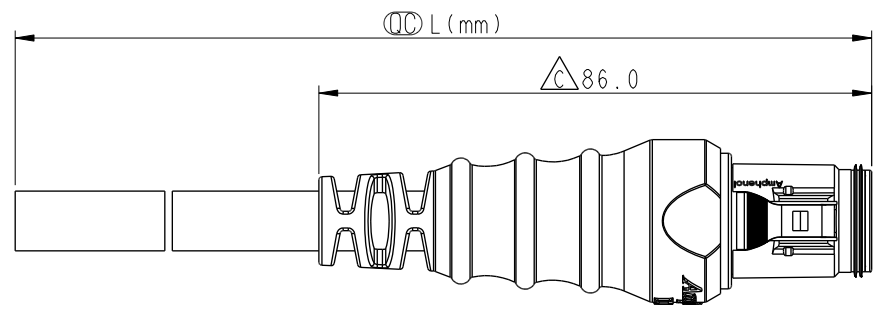

Conn.

- △B Note:
- \* RoHS Compliant
  - \* (L) Important dimension
  - \* Waterproof rate: IP68, mated 1m/24h
  - \* Connector
    - Housing: Thermoplastic, Black
    - Pin: Copper alloy, Gold plated
    - O-Ring: Rubber, Gray
    - Gasket: Rubber, Gray
    - Outer mold: Thermoplastic, Black
  - \* Cable: SJTW, PVC Jacket, Black
  - \* Cable length tolerance: 1M: +50/-0 mm

1M < L ≤ 3M:	+100/-0 mm
3M < L ≤ 5M:	+150/-0 mm
5M < L ≤ 10M:	±100 mm
10M < L ≤ 20M:	±200 mm
20M < L ≤ 30M:	±300 mm
30M < L ≤ 99M:	±500 mm

UNIT: mm			TITLE RBL, C-10A, CABLE W/SR M, M, MOLDING, RBL	△B
TOLERANCE ±0.5mm	SCALE 1:1	SIZE A4	SHEET 1 OF 2	REV. C
	WC-REV. A.5	Ⓞ: Inspection item		

**Amphenol LTW**  
安費諾亮泰企業股份有限公司

ITEM NO.	DRAWN BY Peng	DATE 2019-03-22
DWG NO. CB-XXAMMM-RL8EXX	CHECKED BY Mafei	DATE 2019-03-22
CUSTOMER ALTW	APPROVED BY Jerry	DATE 2019-03-22

THIS DOCUMENT IS SUBJECT TO CHANGE WITHOUT NOTICE. IT IS CONFIDENTIAL AND A PROPERTY OF Amphenol LTW. DISCLOSURE TO THIRD PARTY HAS TO BE AUTHORIZED BY Amphenol LTW.

	4P	9.3	16	CB-04AMMM-RL8EXX
	3P	8.6		CB-03AMMM-RL8EXX
	2P	8.2		CB-02AMMM-RL8EXX
△B	Contacts	Cable OD	AWG	Item No.

△B CB-XXAMMM-RL8EXX

XX: No. Of Pin

XX: 01~99Meters  
 01: 01Meter  
 02: 02Meters  
 :  
 99: 99Meters

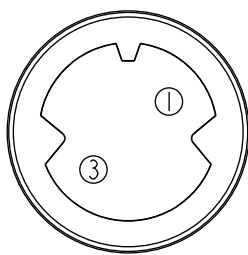
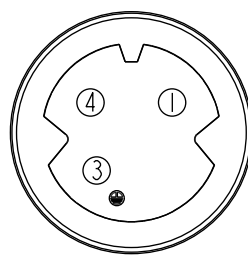
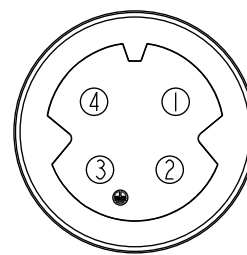
C	Pin Out	4 -- 3 White 白 2 -- 1 Black 黑	4 Green 綠 3 White 白 2 -- 1 Black 黑	4 Green 綠 3 White 白 2 Red 紅 1 Black 黑
	Conn.			
		2P	3P	4P

Pin Assignments Front View

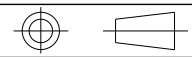
A	UNIT:mm		TITLE	RBL, C-10A, CABLE W/SR M, M, MOLDING, RBL	△B					
	TOLERANCE	±0.5mm	SCALE	1:1	SIZE	A4	SHEET	2	OF	2
			REV.	C	WC-REV.	A.5	◎: Inspection item			

**Amphenol LTW**  
 安費諾亮泰企業股份有限公司

ITEM NO	DRAWN BY	DATE
DWG NO	CHECKED BY	DATE
CUSTOMER	APPROVED BY	DATE
ALTW	Peng Mafei Jerry	2019-03-22 2019-03-22 2019-03-22