

THIS DOCUMENT IS SUBJECT TO CHANGE WITHOUT NOTICE. IT IS CONFIDENTIAL AND A PROPERTY OF Amphenol LTW. DISCLOSURE TO THIRD PARTY HAS TO BE AUTHORIZED BY Amphenol LTW.

REV.	ECN NO.	DATE	SIGN	DESCRIPTION
B	C230419	2023/03/29	Vicky	$\triangle B$ X5
C	C231210	2023/09/15	Vicky	$\triangle C$ XI

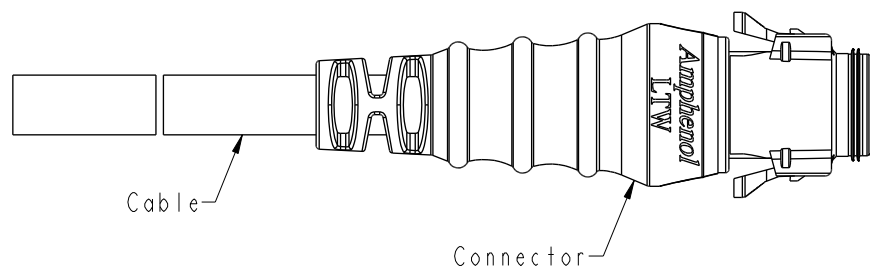
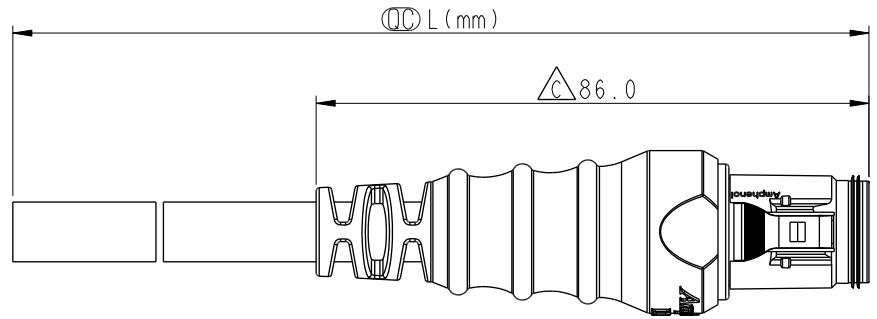

- $\triangle B$ Note:
- * RoHS Compliant
 - * $\text{\textcircled{C}}$ Important dimension
 - * Waterproof rate: IP68, mated 1m/24h
 - * Connector
 - Housing: Thermoplastic, Black
 - Pin: Copper alloy, Gold plated
 - O-Ring: Rubber, Gray
 - Gasket: Rubber, Gray
 - Outer mold: Thermoplastic, Black
 - * Cable: SJTW, PVC Jacket, Black
 - * Cable length tolerance:
 - 1M < L \leq 3M: +100/-0 mm
 - 3M < L \leq 5M: +150/-0 mm
 - 5M < L \leq 10M: \pm 100 mm
 - 10M < L \leq 20M: \pm 200 mm
 - 20M < L \leq 30M: \pm 300 mm
 - 30M < L \leq 99M: \pm 500 mm

UNIT: mm			TITLE RBL, C-10A, CABLE W/SR M, F, MOLDING, RBL	$\triangle B$
TOLERANCE $\pm 0.5\text{mm}$	SCALE 1:1	SIZE A4	SHEET 1 OF 2	REV. C
	WC-REV. A.5	$\text{\textcircled{C}}$: Inspection item		

Amphenol LTW
安費諾亮泰企業股份有限公司

ITEM NO.	DRAWN BY Peng	DATE 2019-03-22
DWG NO. CB-XXAMFM-RL8EXX	CHECKED BY Mafei	DATE 2019-03-22
CUSTOMER ALTW	APPROVED BY Jerry	DATE 2019-03-22



THIS DOCUMENT IS SUBJECT TO CHANGE WITHOUT NOTICE. IT IS CONFIDENTIAL AND A PROPERTY OF Amphenol LTW. DISCLOSURE TO THIRD PARTY HAS TO BE AUTHORIZED BY Amphenol LTW.

4P		9.3	16	CB-04AMFM-RL8EXX
3P		8.6		CB-03AMFM-RL8EXX
2P		8.2		CB-02AMFM-RL8EXX
Contacts	Cable OD	AWG	Item No.	

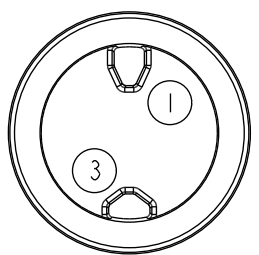
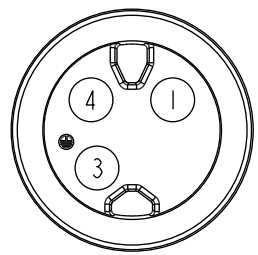
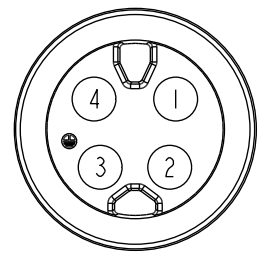
$\triangle B$ CB-XXAMFM-RL8EXX
 XX: No. Of Pin
 XX: 01~99Meters
 01: 01Meter
 02: 02Meters
 :
 99: 99Meters

Pin Out	4	--	4	Green	綠	4	Green	綠
	3	White	3	White	白	3	White	白
	2	--	2	--		2	Red	紅
	1	Black	1	Black	黑	1	Black	黑
Conn.								
	2P		3P		4P			

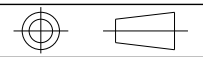
Pin Assignments Front View

UNIT: mm TOLERANCE $\pm 0.5mm$			TITLE RBL, C-10A, CABLE W/SR M, F, MOLDING, RBL	$\triangle B$ Amphenol LTW 安費諾亮泰企業股份有限公司	ITEM NO	DRAWN BY Peng	DATE 2019-03-22
	SCALE 1:1	SIZE A4	SHEET 2 OF 2		DWG NO CB-XXAMFM-RL8EXX	CHECKED BY Mafei	DATE 2019-03-22
	REV. C	WC-REV. A.5	 Inspection item		CUSTOMER ALTW	APPROVED BY Jerry	DATE 2019-03-22