

THIS DOCUMENT IS SUBJECT TO CHANGE WITHOUT NOTICE. IT IS CONFIDENTIAL AND A PROPERTY OF Amphenol LTW. DISCLOSURE TO THIRD PARTY HAS TO BE AUTHORIZED BY Amphenol LTW.

REV.	ECN NO.	DATE	SIGN	DESCRIPTION
B	C230313	2023/03/14	Ruru	$\triangle B$ X6
C	C231210	2023/09/15	Vicky	$\triangle C$ XI

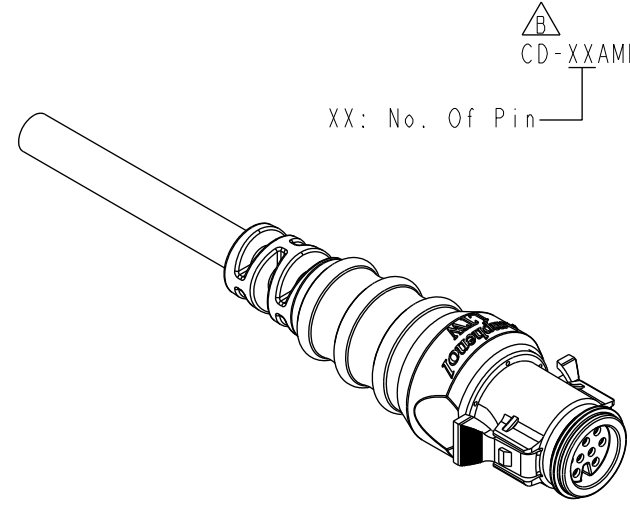
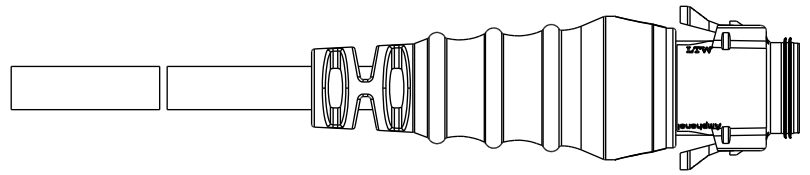

$\triangle B$
CD-XXAMFM-RL8DXX

XX: No. Of Pin

XX: 01~99Meters
01: 01Meter
02: 02Meters
:
99: 99Meters

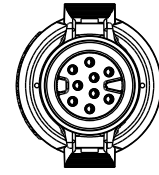
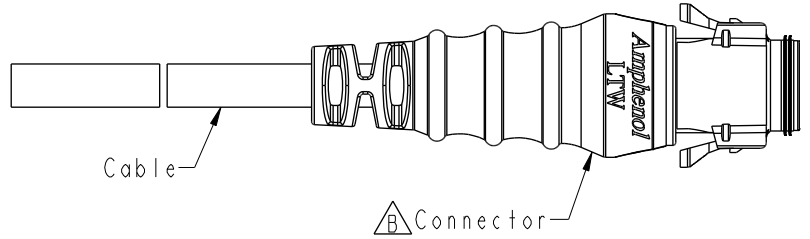
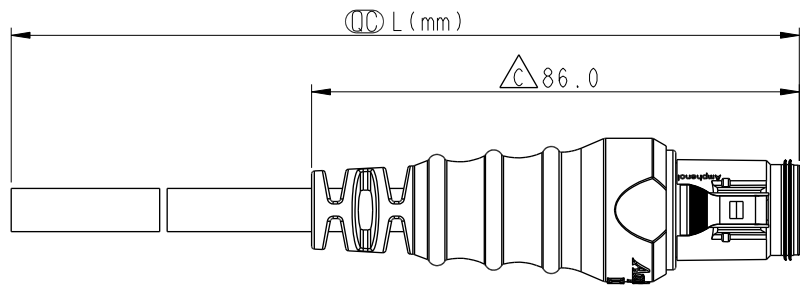

Conn.

Note: $\triangle B$

- * RoHS Compliant
- * \circ Important dimension
- * Waterproof rate: IP68, mated 1m/24h
- * Connector
Housing: Thermoplastic, Black
Pin: Copper Alloy, Gold Plated
O-Ring: Rubber, Gray
Outer mold: Thermoplastic, Black
- * Cable: UL21388, PVC Jacket, Black
- * Cable length tolerance: 1M: +50/-0 mm
1M < L ≤ 3M: +100/-0 mm
3M < L ≤ 5M: +150/-0 mm
5M < L ≤ 10M: ±100 mm
10M < L ≤ 20M: ±200 mm
20M < L ≤ 30M: ±300 mm
30M < L ≤ 99M: ±500 mm
- * Prohibiting the use of place in oils

UNIT:mm		TITLE	RBL, C-5A, CABLE W/SR M, F, MOLDING, RBL $\triangle B$
TOLERANCE	±0.5	SCALE	3:4
		SIZE	A4
		SHEET	1 OF 2
		REV.	C
		WC-REV.	A.1
		\circ Inspection item	

Amphenol LTW
安費諾亮泰企業股份有限公司

ITEM NO	CD-XXAMFM-RL8DXX	DRAWN BY	Peng	DATE	2019-03-02
DWG NO	CD-XXAMFM-RL8DXX	CHECKED BY	Mafei	DATE	2019-03-02
CUSTOMER	ALTW	APPROVED BY	Jerry	DATE	2019-03-02

THIS DOCUMENT IS SUBJECT TO CHANGE WITHOUT NOTICE. IT IS CONFIDENTIAL AND A PROPERTY OF Amphenol LTW. DISCLOSURE TO THIRD PARTY HAS TO BE AUTHORIZED BY Amphenol LTW.



9P	7.6	20	CD-09AMFM-RL8DXX
8P	7.2		CD-08AMFM-RL8DXX
7P	6.8		CD-07AMFM-RL8DXX
6P	6.8		CD-06AMFM-RL8DXX
5P	6.2		CD-05AMFM-RL8DXX
4P	6.0		CD-04AMFM-RL8DXX
3P	5.5		CD-03AMFM-RL8DXX
2P	5.5		CD-02AMFM-RL8DXX
Contacts	Cable OD	AWG	Part No.

9	Gray	灰	9	--	
8	Purple	紫	8	Purple	紫
7	Blue	藍	7	Blue	藍
6	Yellow	黃	6	Yellow	黃
5	Green	綠	5	Green	綠
4	Red	紅	4	Red	紅
3	Brown	棕	3	Brown	棕
2	Orange	橘	2	Orange	橘
1	Black	黑	1	Black	黑

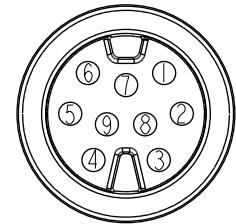

9Pin

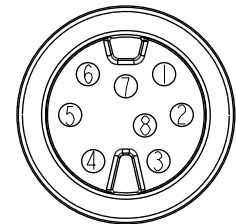

8Pin

Pin Out	4	--	4	Red	紅	4	Red	紅	6	Yellow	黃	6	Yellow	黃	9	--		
	3	Brown	棕	3	Brown	棕	3	Brown	棕	5	--	5	Green	綠	8	--		
	2	--	2	--		2	Orange	橘	4	Red	紅	4	Red	紅	7	Blue	藍	
	1	Black	黑	1	Black	黑	1	Black	黑	3	Brown	棕	3	Brown	棕	6	Yellow	黃
										2	Orange	橘	2	Orange	橘	5	Green	綠
										1	Black	黑	1	Black	黑	4	Red	紅
																3	Brown	棕
																2	Orange	橘
																1	Black	黑

Pin Assignments Front View						
	2Pin	3Pin	4Pin	5Pin	6Pin	7Pin

UNIT:mm TOLERANCE ±0.5	TITLE RBL, C-5A, CABLE W/SR M, F, MOLDING, RBL		Amphenol LTW 安費諾亮泰企業股份有限公司	ITEM NO	DRAWN BY Peng	DATE 2019-03-02	
	SCALE 3:4	SIZE A4		SHEET 2 OF 2	DWG NO CD-XXAMFM-RL8DXX	CHECKED BY Mafei	DATE 2019-03-02
	REV. C	WC-REV. A.1		QC: Inspection item	CUSTOMER ALTW	APPROVED BY Jerry	DATE 2019-03-02