

THIS DOCUMENT IS SUBJECT TO CHANGE WITHOUT NOTICE. IT IS CONFIDENTIAL AND A PROPERTY OF Amphenol LTW. DISCLOSURE TO THIRD PARTY HAS TO BE AUTHORIZED BY Amphenol LTW.

REV.	ECN NO.	DATE	SIGN	DESCRIPTION
B	C230296	2023/05/02	Eagle	△ B x I

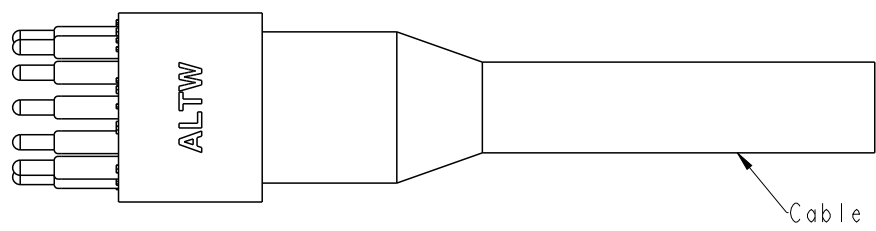

DT-ACM-XXBMM-RLA60

- G3: 3Pin
- G4: 4Pin
- 06: 6Pin
- 08: 8Pin
- 12: 12Pin

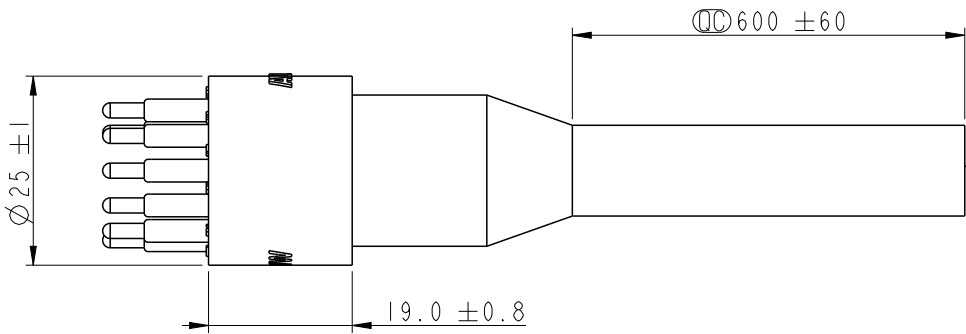
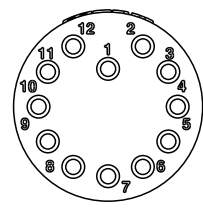

Simple Cut End

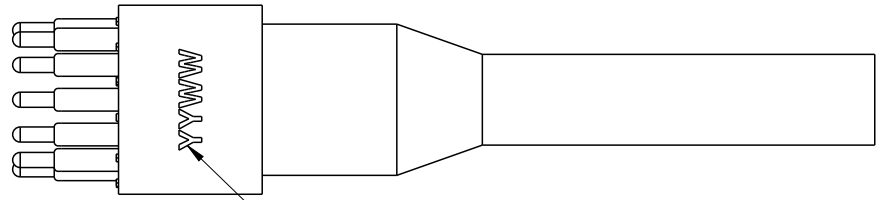

Ⓞ Date Code(Laser mark)
YY(年)
WW(週)
上下左右置中

Note:
 * Ⓞ Important Dimension.
 * Waterproof Rate: Abyssopelagic 4000M, Mated.
 * Connector
 Housing : Rubber, Black.
 Pin : Copper Alloy, Gold Plated.
 * Cable: 18 AWG for 3P/4P.
 20 AWG for 6P/8P/12P.

	AWG	Cable OD(mm)	Wire OD(mm)
3P	18	9.7	2.71
4P	18	9.9	2.71
6P	20	9	1.79
8P	20	10	1.79
12P	20	11.2	1.79

UNIT: mm		
TOLERANCE ±0.5		

TITLE DT, ABY CIRCULAR MICRO CABLE W/O SR, M, M			
SCALE 1:1	SIZE A4	SHEET 1 OF 4	
REV. B	WC-REV. A.5	Ⓞ: Inspection item	

Amphenol LTW
安費諾亮泰企業股份有限公司

ITEM NO	DRAWN BY Eagle	DATE 2022/11/08
DWG NO DT-ACM-XXBMM-RLA60	CHECKED BY Aric	DATE 2022/11/08
CUSTOMER ALTW	APPROVED BY Max	DATE 2022/11/08

THIS DOCUMENT IS SUBJECT TO CHANGE WITHOUT NOTICE. IT IS CONFIDENTIAL AND A PROPERTY OF Amphenol LTW. DISCLOSURE TO THIRD PARTY HAS TO BE AUTHORIZED BY Amphenol LTW.

For 3P/4P/6P/8P

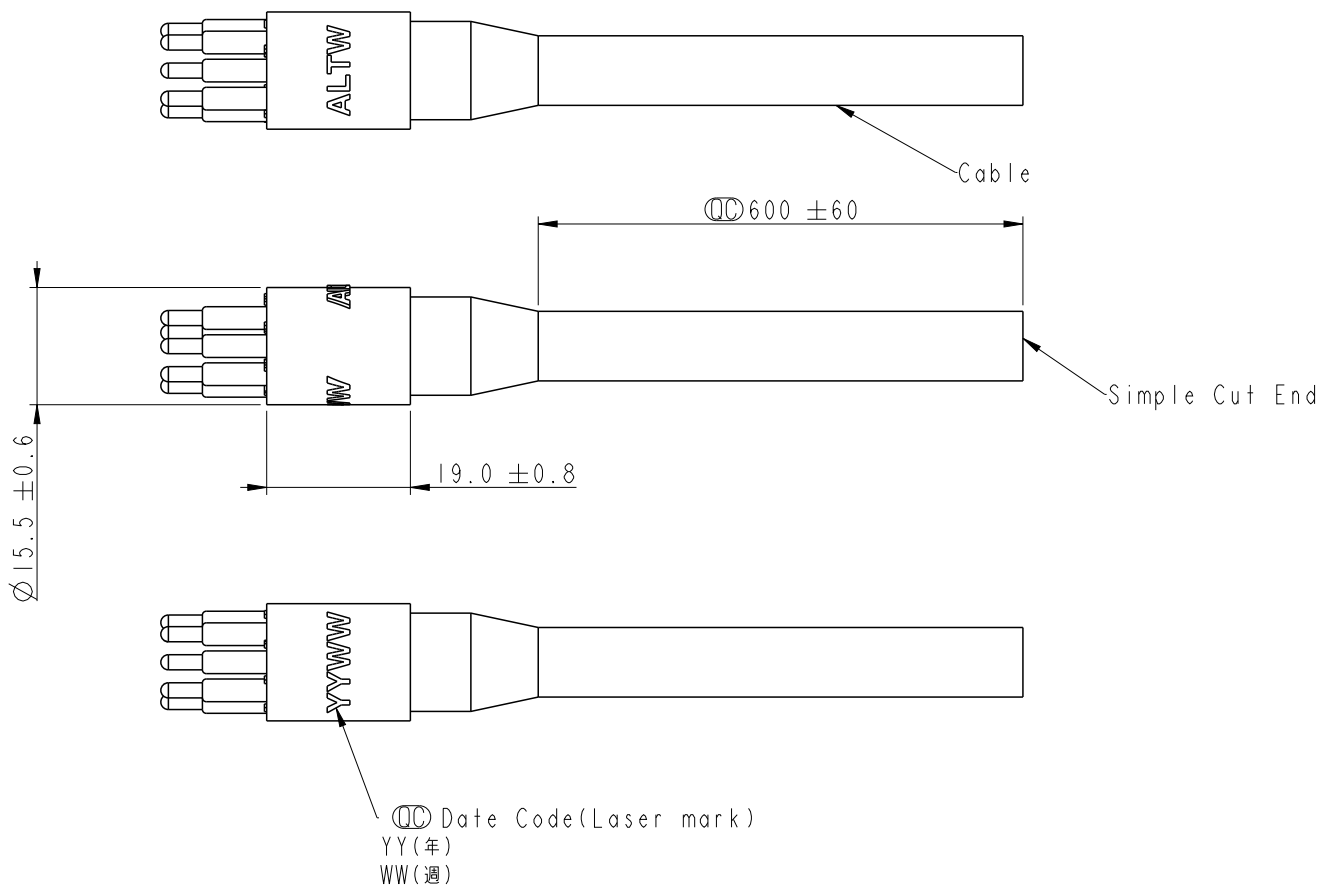
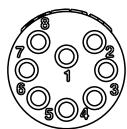

UNIT:mm
 TOLERANCE
 ± 0.5

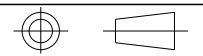

TITLE DT, ABY CIRCULAR MICRO CABLE W/O SR, M, M			
SCALE 1:1	SIZE A4	SHEET 2 OF 4	
REV. B	WC-REV.	CC : Inspection item	

Amphenol LTW
 安費諾亮泰企業股份有限公司

ITEM NO	DRAWN BY Eagle	DATE 2022/11/08
DWG NO DT-ACM-XXBMM-RLA60	CHECKED BY Aric	DATE 2022/11/08
CUSTOMER ALTW	APPROVED BY Max	DATE 2022/11/08

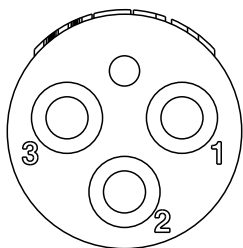

Pin Assignment(Front View)

- Pin Out (3P)
 1 Black(黑) 18AWG
 2 White(白) 18AWG
 3 Red(紅) 18AWG

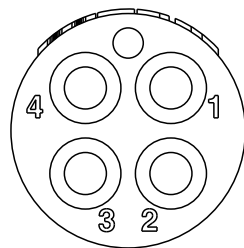

Pin Assignment(Front View)

- Pin Out (4P)
 1 Black(黑) 18AWG
 2 White(白) 18AWG
 3 Red(紅) 18AWG
 4 Green(綠) 18AWG

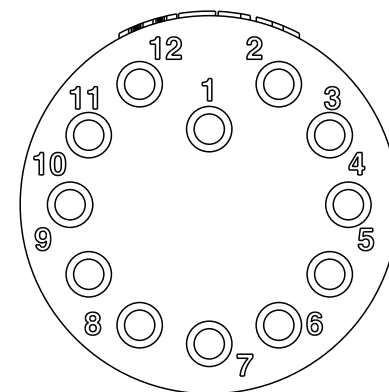

Pin Assignment(Front View)

- Pin Out (12P)
 1 Black(黑) 20AWG
 2 White(白) 20AWG
 3 Red(紅) 20AWG
 4 Green(綠) 20AWG
 5 Orange(橙) 20AWG
 6 Blue(藍) 20AWG
 7 White/Black(白/黑) 20AWG
 8 Red/Black(紅/黑) 20AWG
 9 Green/Black(綠/黑) 20AWG
 10 Orange/Black(橙/黑) 20AWG
 11 Blue/Black(藍/黑) 20AWG
 12 Black/White(黑/白) 20AWG

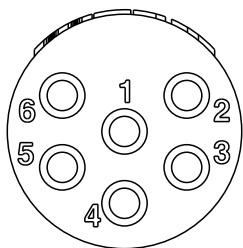

Pin Assignment(Front View)

- Pin Out (6P)
 1 Black(黑) 20AWG
 2 White(白) 20AWG
 3 Red(紅) 20AWG
 4 Green(綠) 20AWG
 5 Orange(橙) 20AWG
 6 Blue(藍) 20AWG

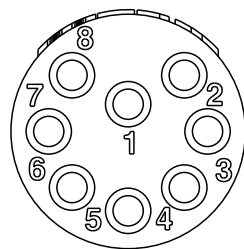

Pin Assignment(Front View)

- Pin Out (8P)
 1 Black(黑) 20AWG
 2 White(白) 20AWG
 3 Red(紅) 20AWG
 4 Green(綠) 20AWG
 5 Orange(橙) 20AWG
 6 Blue(藍) 20AWG
 7 White/Black(白/黑) 20AWG
 8 Red/Black(紅/黑) 20AWG

UNIT:mm
 TOLERANCE
 ±0.5

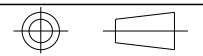

TITLE DT, ABY CIRCULAR MICRO CABLE W/O SR, M, M			
SCALE 1:1	SIZE A4	SHEET 3 OF 4	
REV. B	WC-REV.	QC: Inspection item	

Amphenol LTW
 安費諾亮泰企業股份有限公司

ITEM NO	DRAWN BY Eagle	DATE 2022/11/08
DWG NO DT-ACM-XXBMM-RLA60	CHECKED BY Aric	DATE 2022/11/08
CUSTOMER ALTW	APPROVED BY Max	DATE 2022/11/08

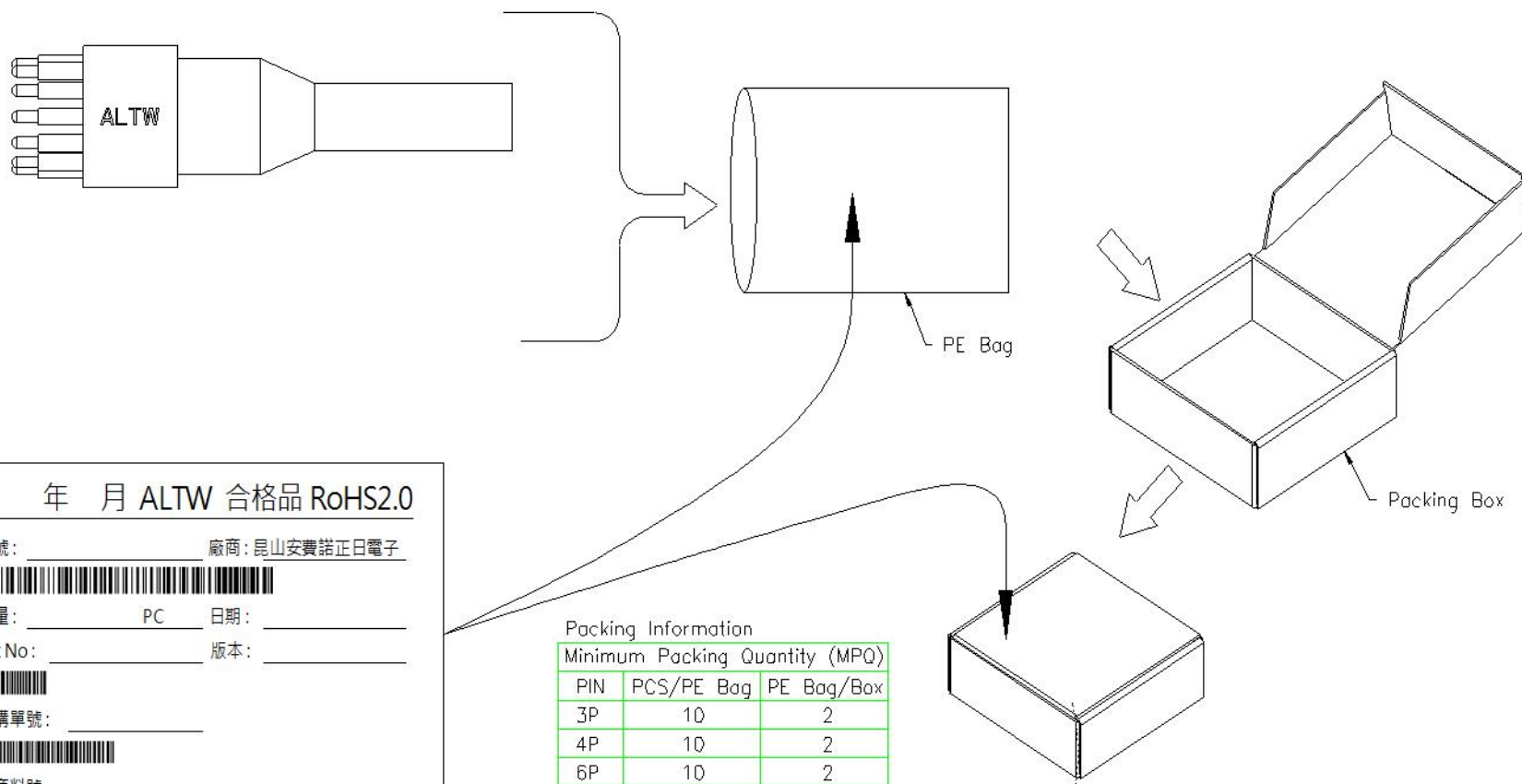

年 月 ALTW 合格品 RoHS2.0

料號: _____ 廠商: 昆山安費諾正日電子

數量: _____ PC 日期: _____

Lot No: _____ 版本: _____

採購單號: _____

廠商料號: _____

Packing Information

Minimum Packing Quantity (MPQ)		
PIN	PCS/PE Bag	PE Bag/Box
3P	10	2
4P	10	2
6P	10	2
8P	10	2
12P	10	2

Connector will be packed in PE bag if order is less than MPQ

UNIT: mm

TOLERANCE
±0.5

TITLE
DT, ABY CIRCULAR MICRO
CABLE W/O SR, M, M

SCALE 1:1	SIZE A4	SHEET 4 OF 4
REV. B	WC-REV.	☉: Inspection item

Amphenol LTW
安費諾亮泰企業股份有限公司

ITEM NO	DRAWN BY Eagle	DATE 2022/11/08
DWG NO DT-ACM-XXBMM-RLA60	CHECKED BY Aric	DATE 2022/11/08
CUSTOMER ALTW	APPROVED BY Max	DATE 2022/11/08