

THIS DOCUMENT IS SUBJECT TO CHANGE WITHOUT NOTICE. IT IS CONFIDENTIAL AND A PROPERTY OF AMPHENOL LTW. DISCLOSURE TO THIRD PARTY HAS TO BE AUTHORIZED BY AMPHENOL LTW.

REV.	ECN NO.	DATE	SIGN	DESCRIPTION
B	C230024	2023/01/06	Eagle	$\triangle B$ x2
C	C230296	2023/05/02	Eagle	$\triangle C$ x1

DT-ACN-XXRFF-RHA30

For 12P

G3: 3Pin
G4: 4Pin
G6: 6Pin
08: 8Pin
12: 12Pin

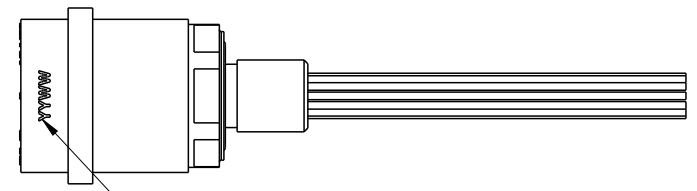
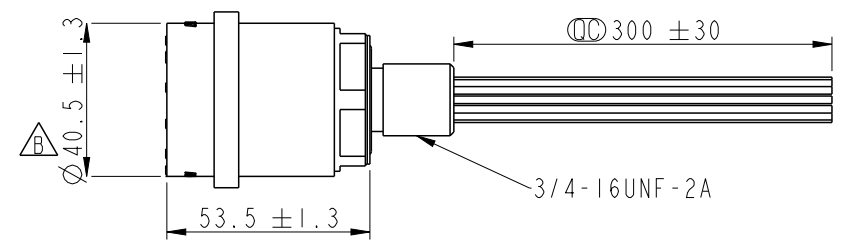
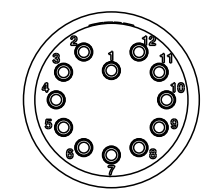
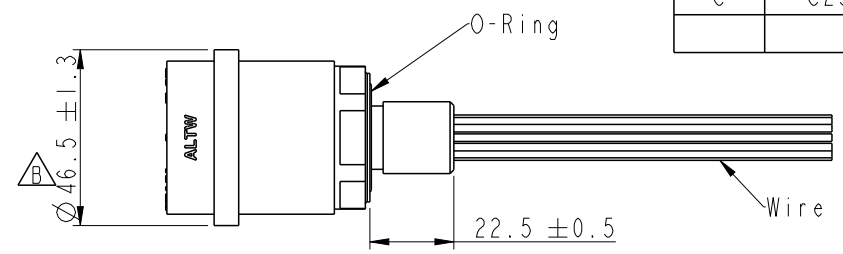

CC Date Code(Laser mark)
YY(年)
WW(週)
上下左右置中

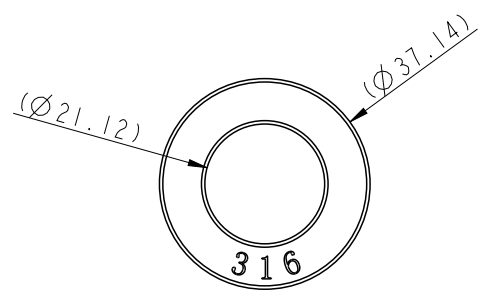

Washer

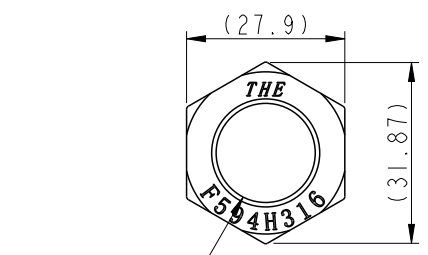
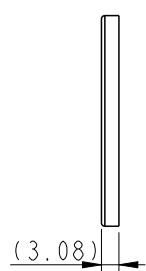

Nut

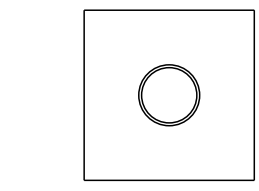
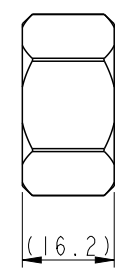

6.40 (Min.)/11.1 (Max.)
Panel cut out (screw type)

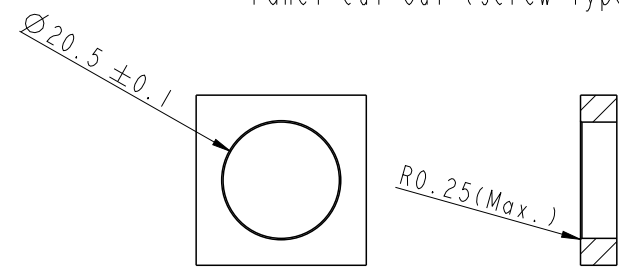

6.40 (Min.)/11.1 (Max.)
Panel cut out (hole type)

- Note:
- * CC Important Dimension.
 - * Waterproof Rate: Abyssopelagic 4000M, Mated.
 - * Connector
Housing : Rubber, Black.
Pin : Copper Alloy, Gold Plated.
O-Ring: Rubber, Black.
Shield: Metal.
Nut: Metal.
Washer: Metal.
 - * Wire: UL10393 18 AWG, OD 1.81mm
 - * Washer and nut are packed separately in PE bag.

UNIT: mm TOLERANCE ±0.5	DT, ABY CIRCULAR MINI REAR FASTENED, F, F		Amphenol LTW 安費諾亮泰企業股份有限公司		ITEM NO	DRAWN BY	DATE
	SCALE	SIZE			SHEET	OF	DWG NO
	REV.	WC-REV.	CC : Inspection item		CUSTOMER	APPROVED BY	DATE

THIS DOCUMENT IS SUBJECT TO CHANGE WITHOUT NOTICE. IT IS CONFIDENTIAL AND A PROPERTY OF Amphenol LTW. DISCLOSURE TO THIRD PARTY HAS TO BE AUTHORIZED BY Amphenol LTW.

For 6P/8P

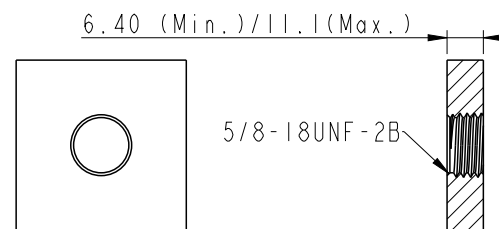
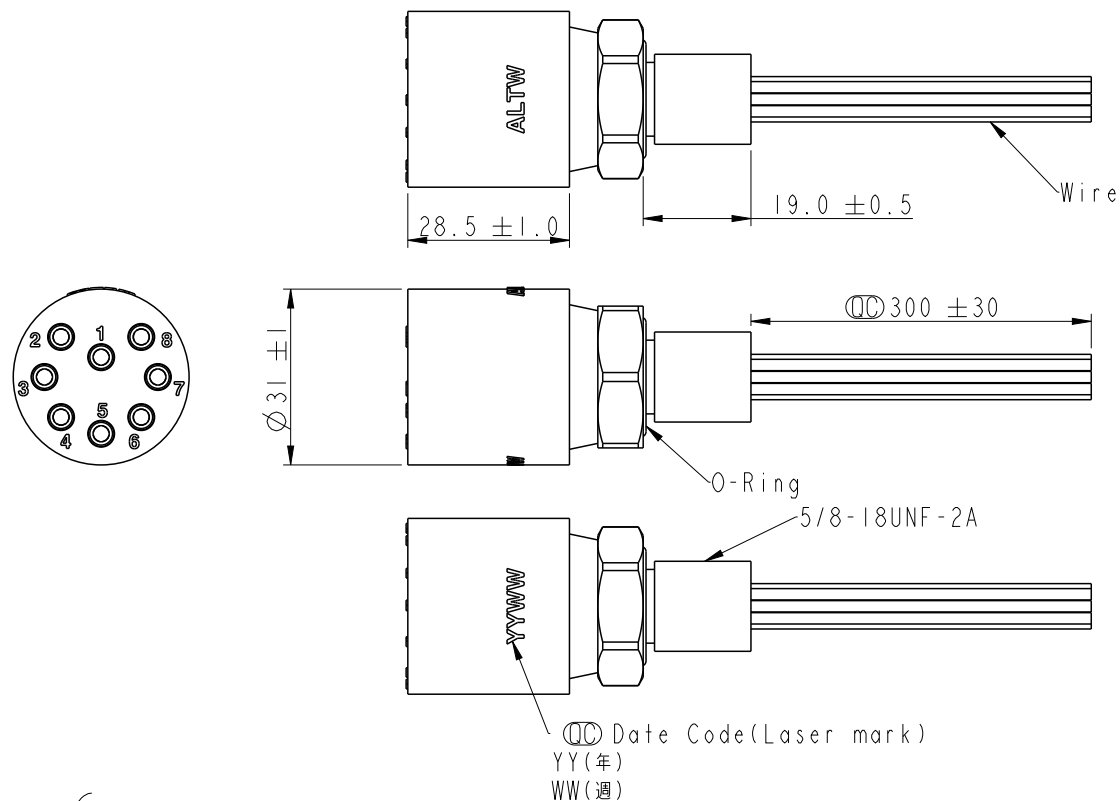

Panel cut out (screw type)

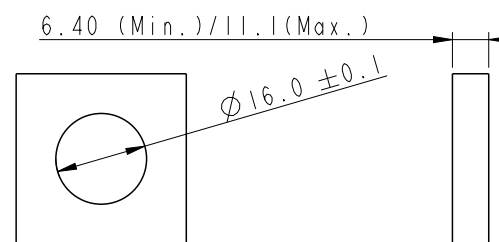

Panel cut out (hole type)

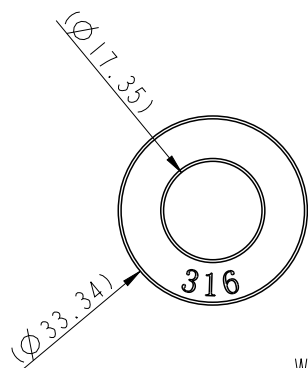

Washer

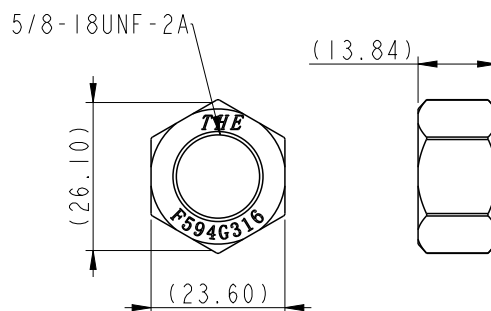

Nut

UNIT: mm

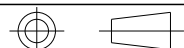

TOLERANCE
± 0.5

TITLE DT, ABY CIRCULAR MINI REAR FASTENED, F, F			
SCALE 1:1	SIZE A4	SHEET 2 OF 5	
REV. C	WC-REV. A.5	☉: Inspection item	

Amphenol LTW
安費諾亮泰企業股份有限公司

ITEM NO	DRAWN BY Eagle	DATE 2022/11/08
DWG NO DT-ACN-XXRFF-RHA30	CHECKED BY Aric	DATE 2022/11/08
CUSTOMER ALTW	APPROVED BY Max	DATE 2022/11/08

THIS DOCUMENT IS SUBJECT TO CHANGE WITHOUT NOTICE. IT IS CONFIDENTIAL AND A PROPERTY OF Amphenol LTW. DISCLOSURE TO THIRD PARTY HAS TO BE AUTHORIZED BY Amphenol LTW.

For 3P/4P

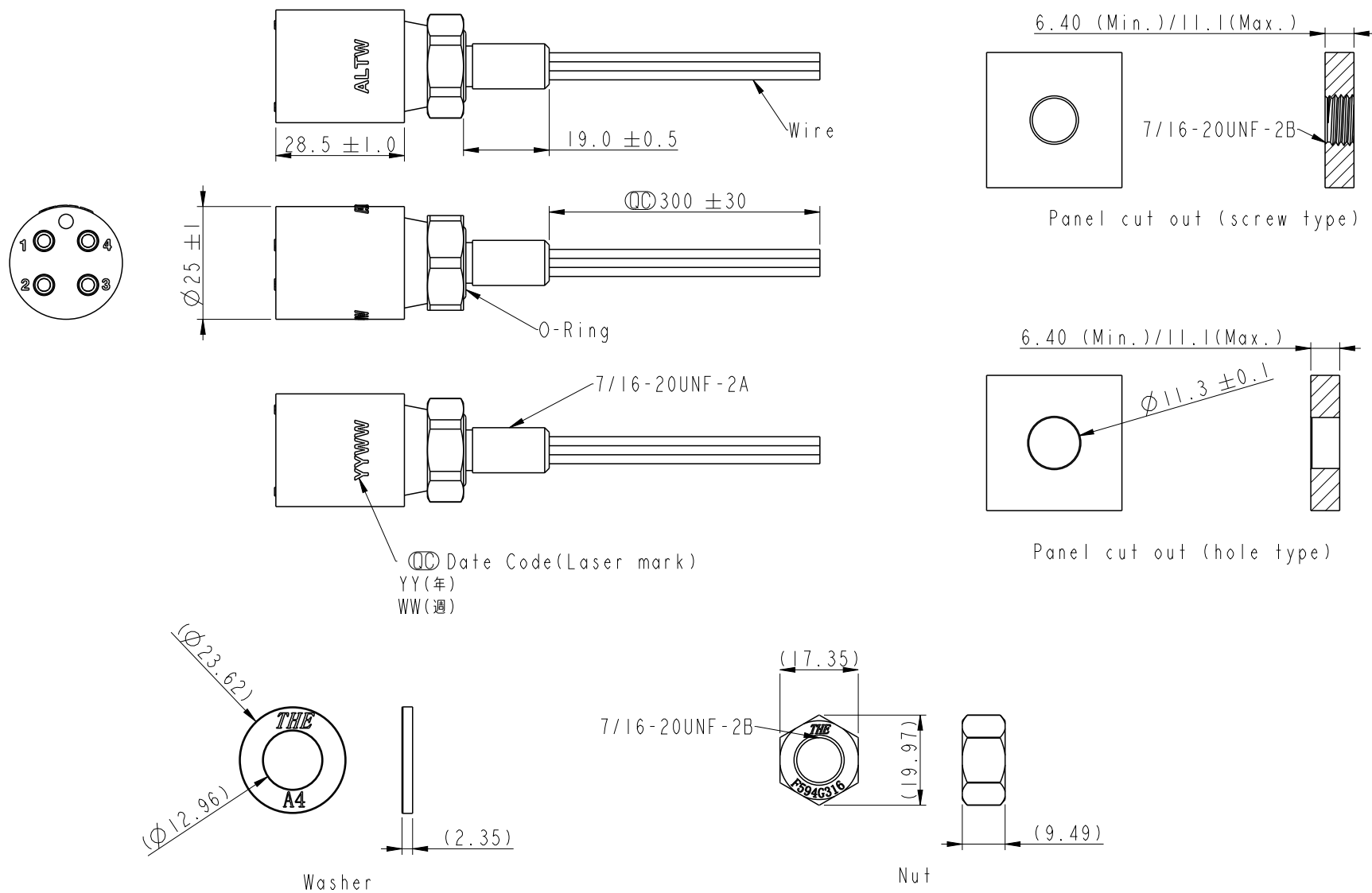

UNIT:mm

TOLERANCE
±0.5

TITLE DT, ABY CIRCULAR MINI REAR FASTENED, F, F			
SCALE 1:1	SIZE A4	SHEET 3 OF 5	
REV. C	WC-REV. A.5	Ⓞ: Inspection item	

Amphenol LTW
安費諾亮泰企業股份有限公司

ITEM NO	DRAWN BY Eagle	DATE 2022/11/08
DWG NO DT-ACN-XXRFF-RHA30	CHECKED BY Aric	DATE 2022/11/08
CUSTOMER ALTW	APPROVED BY Max	DATE 2022/11/08

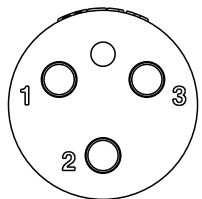

Pin Assignment(Front View)

- Pin Out (3P)
 1 Black(黑) 18AWG
 2 White(白) 18AWG
 3 Red(紅) 18AWG

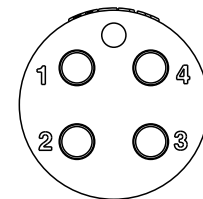

Pin Assignment(Front View)

- Pin Out (4P)
 1 Black(黑) 18AWG
 2 White(白) 18AWG
 3 Red(紅) 18AWG
 4 Green(綠) 18AWG

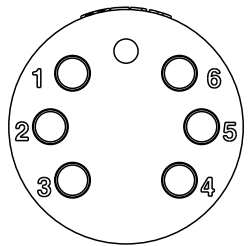

Pin Assignment(Front View)

- Pin Out (6P)
 1 Black(黑) 18AWG
 2 White(白) 18AWG
 3 Red(紅) 18AWG
 4 Green(綠) 18AWG
 5 Orange(橙) 18AWG
 6 Blue(藍) 18AWG

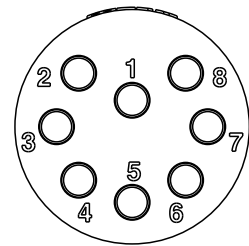

Pin Assignment(Front View)

- Pin Out (8P)
 1 Black(黑) 18AWG
 2 White(白) 18AWG
 3 Red(紅) 18AWG
 4 Green(綠) 18AWG
 5 Orange(橙) 18AWG
 6 Blue(藍) 18AWG
 7 White/Black(白/黑) 18AWG
 8 Red/Black(紅/黑) 18AWG

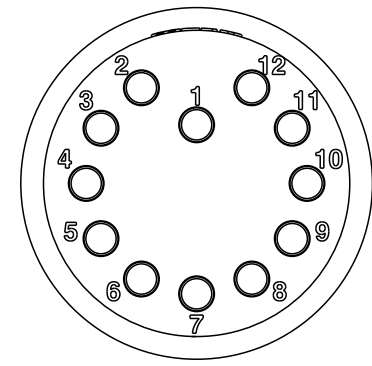

Pin Assignment(Front View)

- Pin Out (12P)
 1 Black(黑) 18AWG
 2 White(白) 18AWG
 3 Red(紅) 18AWG
 4 Green(綠) 18AWG
 5 Orange(橙) 18AWG
 6 Blue(藍) 18AWG
 7 White/Black(白/黑) 18AWG
 8 Red/Black(紅/黑) 18AWG
 9 Green/Black(綠/黑) 18AWG
 10 Orange/Black(橙/黑) 18AWG
 11 Blue/Black(藍/黑) 18AWG
 12 Black/White(黑/白) 18AWG

UNIT:mm
 TOLERANCE

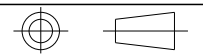

TITLE DT, ABY CIRCULAR MINI REAR FASTENED, F, F			
SCALE 1:2	SIZE A4	SHEET 4 OF 5	
REV. C	WC-REV.	QC: Inspection item	

Amphenol LTW
 安費諾亮泰企業股份有限公司

ITEM NO	DWG NO DT-ACN-XXRFF-RHA30
CUSTOMER ALTW	

DRAWN BY Eagle	CHECKED BY Aric
APPROVED BY Max	

DATE 2022/11/08	DATE 2022/11/08
DATE 2022/11/08	

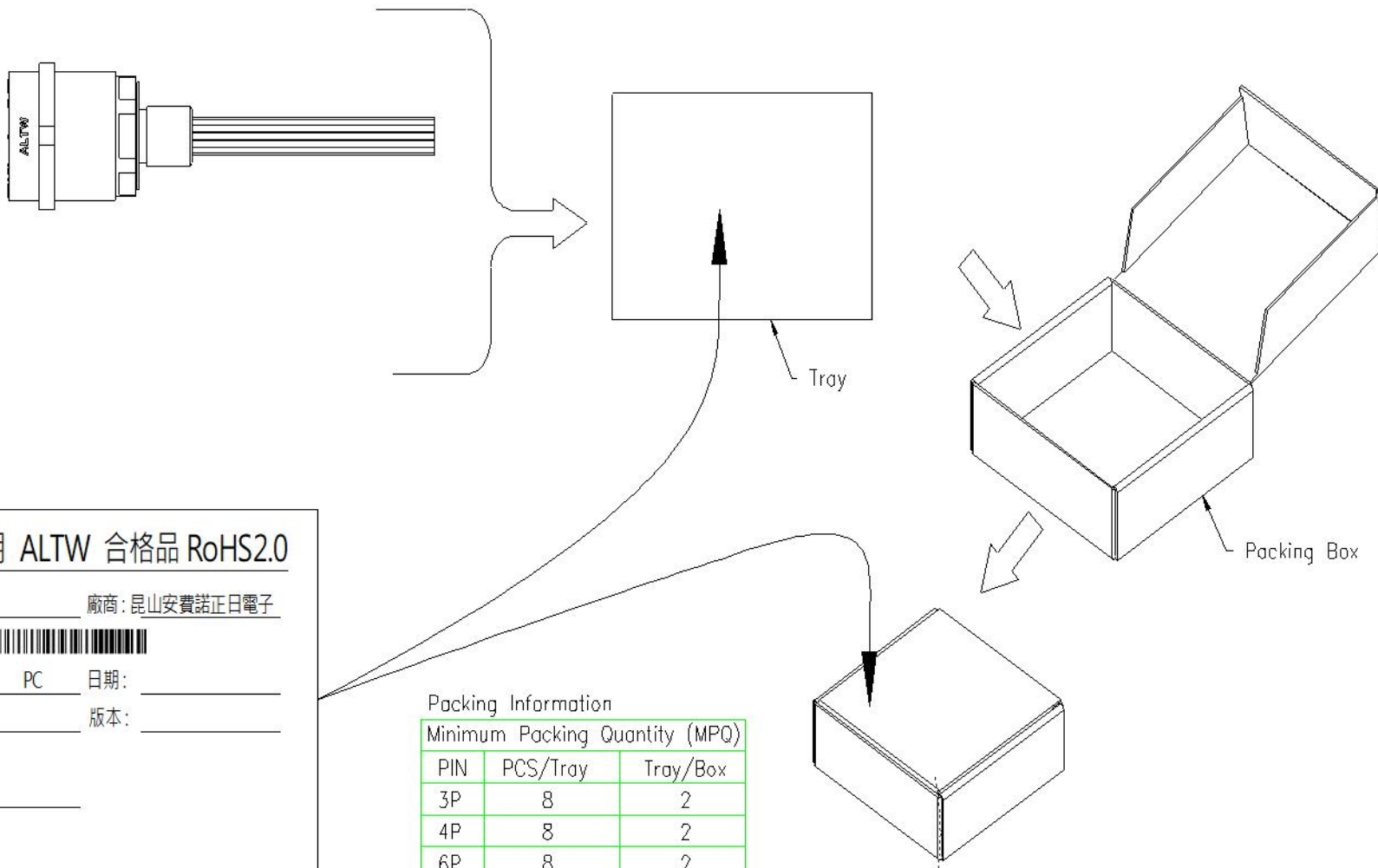

年 月 ALTW 合格品 RoHS2.0

料號: _____ 廠商: 昆山安費諾正日電子

數量: _____ PC 日期: _____

Lot No: _____ 版本: _____

採購單號: _____

廠商料號: _____

Packing Information

Minimum Packing Quantity (MPQ)		
PIN	PCS/Tray	Tray/Box
3P	8	2
4P	8	2
6P	8	2
8P	8	2
12P	8	1

Connector will be packed in PE bag if order is less than MPQ

UNIT: mm TOLERANCE ±0.5 	TITLE DT, ABY CIRCULAR MINI REAR FASTENED, F, F			Amphenol LTW 安費諾亮泰企業股份有限公司	ITEM NO DT-ACN-XXRFF-RHA30	DRAWN BY Eagle	DATE 2022/11/08
	SCALE 1:1	SIZE A4	SHEET 5 OF 5		CUSTOMER ALTW	CHECKED BY Aric	DATE 2022/11/08
	REV. C	WC-REV. A.5	Inspection item		APPROVED BY Max	DATE 2022/11/08	