

THIS DOCUMENT IS SUBJECT TO CHANGE WITHOUT NOTICE. IT IS CONFIDENTIAL AND A PROPERTY OF AMPHENOL LTW. DISCLOSURE TO THIRD PARTY HAS TO BE AUTHORIZED BY AMPHENOL LTW.

REV.	ECN NO.	DATE	SIGN	DESCRIPTION
A		2022/09/30	Eagle	Rev.01 to Rev.A
B	C230296	2023/05/02	Eagle	\triangle B x1

For 12P

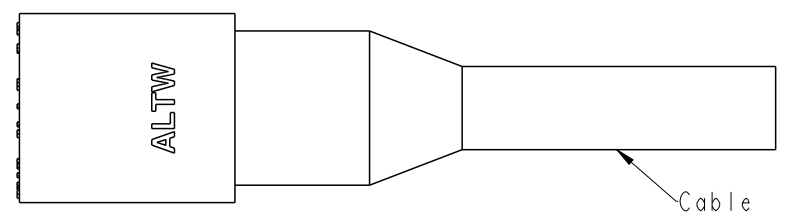

DT-HCM-XXBFF-RLA60

- G3: 3Pin
- G4: 4Pin
- 06: 6Pin
- 08: 8Pin
- 12: 12Pin

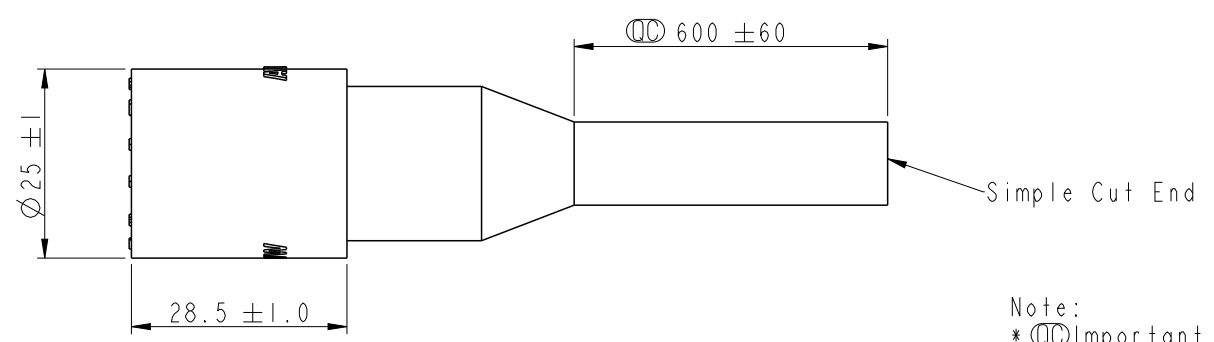
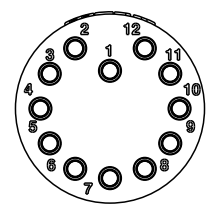

Note:
 * CC Important Dimension.
 * Waterproof Rate: Hadopelagic 7000M, Mated.
 * Connector Housing : Rubber, Black.
 Pin : Copper Alloy, Gold Plated.
 * Cable: 18 AWG for 3P/4P.
 20 AWG for 6P/8P/12P.

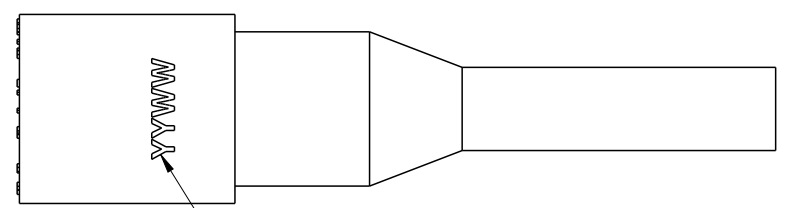

CC Date Code(Laser mark)
 YY(年)
 WW(週)

	AWG	Cable OD(mm)	Wire OD(mm)
3P	18	9.7	2.71
4P	18	9.9	2.71
6P	20	9	1.79
8P	20	10	1.79
12P	20	11.2	1.79

UNIT: mm		
TOLERANCE ±0.5		

TITLE DT, HAD CIRCULAR MICRO CABLE W/O SR, F, F			
SCALE 1:1	SIZE A4	SHEET 1 OF 4	
REV. B	WC-REV. A.5	CC : Inspection item	

Amphenol LTW
 安費諾亮泰企業股份有限公司

ITEM NO	DRAWN BY Eagle	DATE 2022/09/30
DWG NO DT-HCM-XXBFF-RLA60	CHECKED BY Aric	DATE 2022/09/30
CUSTOMER ALTW	APPROVED BY Max	DATE 2022/09/30

THIS DOCUMENT IS SUBJECT TO CHANGE WITHOUT NOTICE. IT IS CONFIDENTIAL AND A PROPERTY OF AMPHENOL LTW. DISCLOSURE TO THIRD PARTY HAS TO BE AUTHORIZED BY AMPHENOL LTW.

For 3P/4P/6P/8P

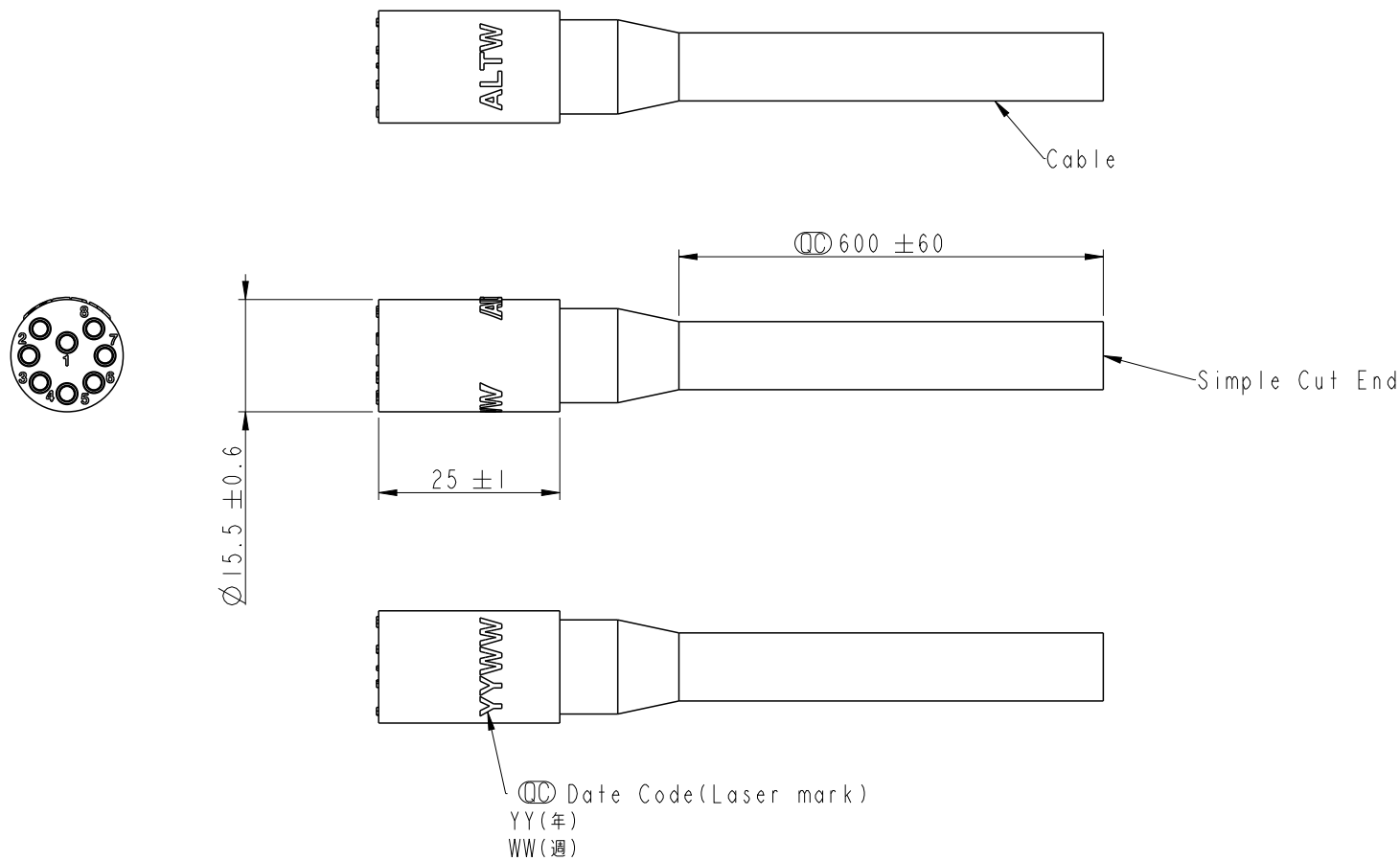

UNIT: mm
 TOLERANCE
 ± 0.5

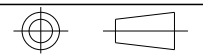

TITLE DT, HAD CIRCULAR MICRO CABLE W/O SR, F, F			
SCALE 1:1	SIZE A4	SHEET 2 OF 4	
REV. B	WC-REV.	CC : Inspection item	

Amphenol LTW
 安費諾亮泰企業股份有限公司

ITEM NO	DRAWN BY Eagle	DATE 2022/09/30
DWG NO DT-HCM-XXBFF-RLA60	CHECKED BY Aric	DATE 2022/09/30
CUSTOMER ALTW	APPROVED BY Max	DATE 2022/09/30

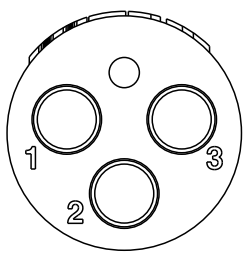

Pin Assignment(Front View)

- Pin Out (3P)
 1 Black(黑) 18AWG
 2 White(白) 18AWG
 3 Red(紅) 18AWG

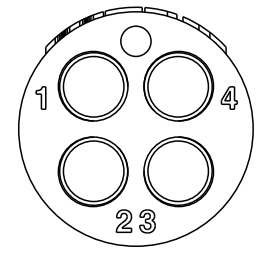

Pin Assignment(Front View)

- Pin Out (4P)
 1 Black(黑) 18AWG
 2 White(白) 18AWG
 3 Red(紅) 18AWG
 4 Green(綠) 18AWG

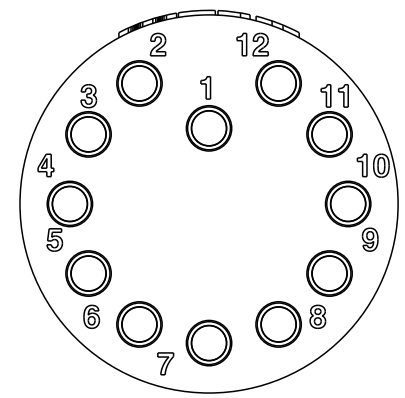

Pin Assignment(Front View)

- Pin Out (12P)
 1 Black(黑) 20AWG
 2 White(白) 20AWG
 3 Red(紅) 20AWG
 4 Green(綠) 20AWG
 5 Orange(橙) 20AWG
 6 Blue(藍) 20AWG
 7 White/Black(白/黑) 20AWG
 8 Red/Black(紅/黑) 20AWG
 9 Green/Black(綠/黑) 20AWG
 10 Orange/Black(橙/黑) 20AWG
 11 Blue/Black(藍/黑) 20AWG
 12 Black/White(黑/白) 20AWG

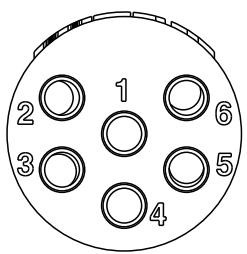

Pin Assignment(Front View)

- Pin Out (6P)
 1 Black(黑) 20AWG
 2 White(白) 20AWG
 3 Red(紅) 20AWG
 4 Green(綠) 20AWG
 5 Orange(橙) 20AWG
 6 Blue(藍) 20AWG

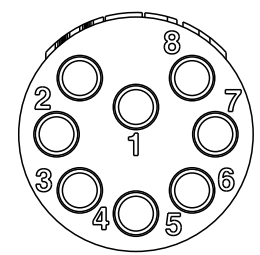

Pin Assignment(Front View)

- Pin Out (8P)
 1 Black(黑) 20AWG
 2 White(白) 20AWG
 3 Red(紅) 20AWG
 4 Green(綠) 20AWG
 5 Orange(橙) 20AWG
 6 Blue(藍) 20AWG
 7 White/Black(白/黑) 20AWG
 8 Red/Black(紅/黑) 20AWG

UNIT:mm

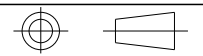

TITLE DT, HAD CIRCULAR MICRO CABLE W/O SR, F, F			
SCALE 1:1	SIZE A4	SHEET 3 OF 4	
REV. B	WC-REV.	QC: Inspection item	

Amphenol LTW
 安費諾亮泰企業股份有限公司

ITEM NO	DRAWN BY Eagle	DATE 2022/09/30
DWG NO DT-HCM-XXBFF-RLA60	CHECKED BY Aric	DATE 2022/09/30
CUSTOMER ALTW	APPROVED BY Max	DATE 2022/09/30

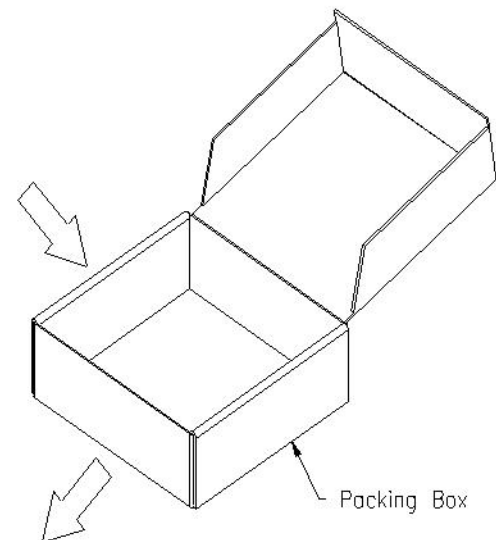
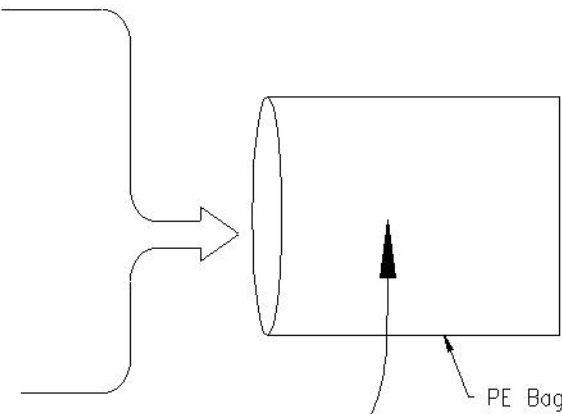
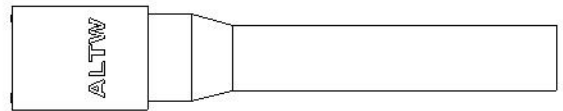

年 月 ALTW 合格品 RoHS2.0

料號: _____ 廠商: 昆山安費諾正日電子



數量: _____ PC 日期: _____

Lot No: _____ 版本: _____



採購單號: _____



廠商料號: _____

Packing Information

Minimum Packing Quantity (MPQ)		
PIN	PCS/PE Bag	PE Bag/Box
3P	10	2
4P	10	2
6P	10	2
8P	10	2
12P	10	2

Connector will be packed in PE bag if order is less than MPQ

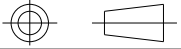
UNIT: mm TOLERANCE ±0.5			TITLE DT, HAD CIRCULAR MICRO CABLE W/O SR, F, F		ITEM NO _____		DRAWN BY Eagle		DATE 2022/09/30	
	SCALE 1:1		SIZE A4		SHEET 4 OF 4		CHECKED BY Aric		DATE 2022/09/30	
	REV. B		WC-REV.		 Inspection item		APPROVED BY Max		DATE 2022/09/30	
Amphenol LTW 安費諾亮泰企業股份有限公司					DWG NO DT-HCM-XXBFF-RLA60		CUSTOMER ALTW		DATE 2022/09/30	